



Senza centralina incorporata | Without circuit control

**FARI A LED PER MARCIA DIURNA**

Universali, 6.000 °K.  
Led ultra bianchi ad alta luminescenza.  
Basso assorbimento, lunga durata.  
Alta visibilità in tutte le condizioni atmosferiche

**UNIVERSAL DAY RUNNING LIGHTS**

6.000 °K Color temperature.  
Ultra-white high brightness.  
Low power consumption for fuel saving

**6000°K**  
COLOUR TEMPERATURE

**LED**

**ECE R87**  
OMOLOGATI  
APPROVED

**2**  
pcs

I fari DRL (luci di marcia diurna) possono essere utilizzati solamente durante le ore diurne e non possono essere accesi in contemporanea con gli anabbaglianti.  
DRL Day Running Lights may be turned on during daytime only and may not be used simultaneously with head lights.

Utilizzando questi fari a led con specifica omologazione RL (LUCE DIURNA) non è necessario l'accensione dei fari anabbaglianti e delle luci di posizione.

- minore assorbimento di corrente = minore consumo di carburante
- minore deperimento e consumo di lampade = maggiore risparmio



**DRL S-5**

12V

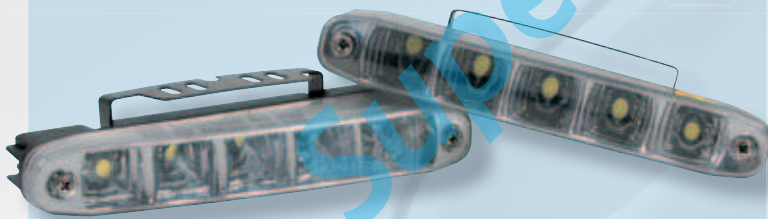

(E)

Con centralina incorporata  
With DRL circuit control

**FARI A LED PER MARCIA DIURNA - DRL S-5 - 12V**  
Con centralina incorporata

**UNIVERSAL DAY RUNNING LIGHTS - DRL S-5 - 12V**  
With DRL circuit control for automatic on/off

**72306** 160 mm

Scatola / Box  3 / 12



Design ad arco - Curved design



**DRL S-5L**

12-24V



(E)

Con centralina incorporata  
With DRL circuit control

**FARI A LED PER MARCIA DIURNA - DRL S5-L - 12/24V**  
Con centralina incorporata

**UNIVERSAL DAY RUNNING LIGHTS - DRL S5-L - 12/24V**  
With DRL circuit control for automatic on/off

**72307** 220 mm

Scatola / Box  3 / 12



Design ad arco - Curved design





**DRL EURONORM, CENTRALINA AUTOMATICA PER FARI MARCIA DIURNA, 12/24V**

Accende i fari diurni e li spegne automaticamente quando vengono accesi gli anabbaglianti, Kit pre-assemblato adatto per art. 72303, 72304, 72305

**CIRCUIT CONTROL WIRE KIT FOR DAY-RUNNING LIGHTS 12/24V**

Turns DRL lights on automatically when vehicle is started and turns them off when headlights are switched-on. Pre-assembled kit fits art. 72303, 72304, 72305

**72301**

Scatola / Box 10 / 20



**DRL R-4**



(E)

**FARI A LED PER MARCIA DIURNA - DRL R-4 - 12/24V**  
Centralina da ordinarsi a parte (art. 72301)

**UNIVERSAL DAY RUNNING LIGHTS - DRL R-4 - 12/24V**  
DRL circuit control to order separately (art. 72301)

**72303** Ø 70 mm

Scatola / Box 10

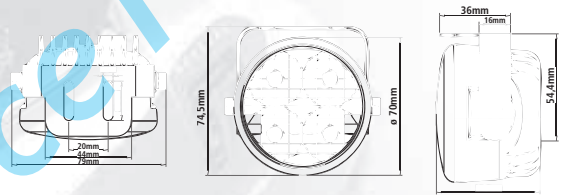

**DRL L-4**



(E)

**FARI A LED PER MARCIA DIURNA - DRL L-4 - 12/24V**  
Centralina da ordinarsi a parte (art. 72301)

**UNIVERSAL DAY RUNNING LIGHTS - DRL L-4 - 12/24V**  
DRL circuit control to order separately (art. 72301)

**72304** 125 mm

Scatola / Box 10

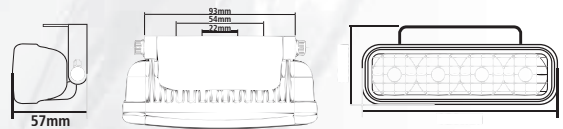

**DRL L-5**



(E)

**FARI A LED PER MARCIA DIURNA - DRL L-5 - 12/24V**  
Centralina da ordinarsi a parte (art. 72301)

**UNIVERSAL DAY RUNNING LIGHTS - DRL L-5 - 12/24V**  
DRL circuit control to order separately (art. 72301)

**72305** 147 mm

Scatola / Box 10

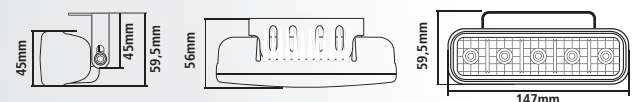



4 pcs

LED

UNIVERSAL

**SET 4 ANELLI ANGEL-EYES, 12V - UNIVERSALI**

Illuminazione tramite Led multipli ad alta luminescenza di colore ultra-bianco, tipo HID, di lunghissima durata e basso consumo. Montaggio facile.

**MULTI-LED ANGEL-EYES SET 4 PCS, 12V - UNIVERSAL**

Super-Bright White Led. Fits into original headlights. Long file span, lower power consumption

**09955**

Scatola / Box  10 / 40

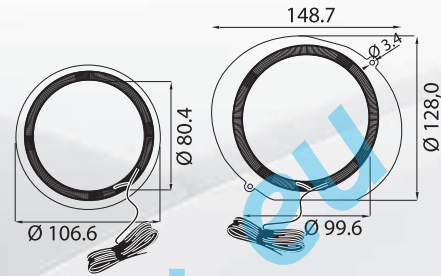

4 pcs

NEON CCFL SUPER BRIGHT

**SET 4 ANELLI ANGEL-EYES 12V, 4 PCS PER BMW E46**

Illuminazione tramite neon CCFL ultra-bianchi ad altissima luminescenza e di lunghissima durata.

**ANGEL-EYES KIT 4 PCS 12V, FOR BMW E46**

Super-Bright CCFL neon. Fits into original headlights. Long life span, over 20.000 hours

**09956**

Scatola / Box  6 / 12



**KIT DI MONTAGGIO PER ART. 09956 CON CAVI E RELÈ**

**MOUNTING KIT FOR ART. 09956 WITH CABLES AND RELAY**

**09956K**

Scatola / Box  66



2 x 3W

**KIT TRASFORMAZIONE LAMPADE LED PER BMW, 2X3W - 7000°K**

Cambia la luce gialla degli anelli originali in xenon ultra bianco

**SUPER-BRIGHT LED LAMP KIT FOR BMW, 2X3W - 7000°K**

Change yellowish light into ultra-bright H.I.D. white

**09957**

Scatola / Box  10 / 40

**LED 7000°K ULTRA-WHITE**

Per BMW:  
E87 (serie 1) 9/04>  
E39 (serie 5) 11/95>6/03  
E60 (serie 5) 7/03>  
E63 (serie 6) 1/04>  
E65-E66 (serie 7) 11/01>  
E53 (X5) 5/00>1/07



2 x 6W

**KIT TRASFORMAZIONE LAMPADE LED PER BMW, 2X6W - 7000°K**

Cambia la luce gialla degli anelli originali in xenon ultra bianco

**SUPER-BRIGHT LED LAMP KIT FOR BMW, 2X6W - 7000°K**

Change yellowish light into ultra-bright H.I.D. white

**09958**

Scatola / Box  10 / 20

**LED 7000°K ULTRA-WHITE**

Per BMW:  
E90 (serie 3) 1/05>

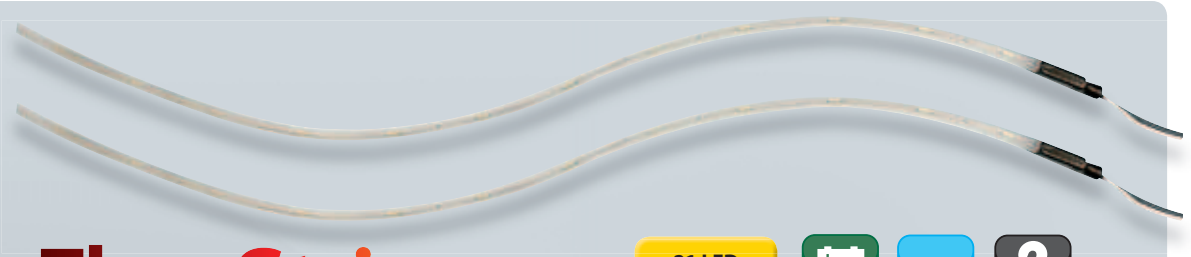

# Flex-Strip

21 LED  
2 x 50 cm

12V

LED

2 pcs



**FLEX STRIP, 2X50 CM - 12V**  
Strisce adesive a Led. Impermeabili, flessibili, ultrasottili, si inseriscono virtualmente in qualsiasi fessura. Basso assorbimento di corrente. Possono essere accorciate semplicemente tramite forbici

**FLEX STRIP, 2X50 CM - 12V**  
Led day-time running lights. Adhesive, weather resistant, for exterior use. Extreme low-profile design, mounts virtually anywhere. Flexible, may be curved to follow light shape. May be cutted simply with scissors

<b>73628</b>	Bianco	White
<b>73629</b>	Rosso	Red

D/Blister 5 / 50



**LAMPADA ALOGENA ROTANTE H3-55W-12V**  
Omologata. Montaggio a vite o con base magnetica, presa accendisigari

**HALOGEN REVOLVING LIGHT H3-55W-12V**  
Approved. Cigarette lighter plug, magnetic and screw type fitting

**73024**

D/Blister 6 / 24

**CALOTTA RICAMBIO PER ART. 73024**  
SPARE LENS FOR ART. 73024

<b>73023</b>	Arancio	Amber
<b>73031</b>	Rosso	Red
<b>73032</b>	Blu	Blue

Sfuso / Bulk 50



**LUCE ROTANTE 21W-12V**  
Presca accendisigari - cavo a spirale da 3,3 m, base magnetica

**REVOLVING LIGHT 21W-12V**  
Cigarette lighter plug with 3,3 m. spiral cable. Magnetic base

**73025**

D/Blister 6 / 24

**CALOTTA RICAMBIO PER ART. 73025**  
SPARE LENS FOR ART. 73025

<b>73027</b>	Arancio	Amber
<b>73033</b>	Rosso	Red

Sfuso / Bulk 50





**FASHION-LITE, 12V**  
Coppia indicatori laterali. Lente colorata ma con fascio luce arancio

**FASHION-LITE, 12V**  
Pair of side marker lights, coloured lens, amber light

<b>72271</b>	Trasparente	Clear
<b>72273</b>	Blu	Blue
<b>72274</b>	Verde	Green

D/Blister  10 / 40



Luca arancio  
Amber light



**SIDE MARKER, LUCI LATERALI 12V, 6 LED**  
Alta luminescenza, lunga durata, basso consumo. Base adesiva 3M®, impermeabili. Omologazione europea, lente neutra con luce arancio

**SIDE MARKER LED LIGHTS, 6 LED**  
New series: european homologation

**72279**

Blister Sfil.  10 / 100



**FUTUR-LED 8 LEDS 12V, COPPIA LUCI MULTIFUNZIONE**  
Flessibili, retro adesivo, led alta luminosità

**FUTUR-LED 8 LEDS 12V**  
Adhesive flexible lights with super-bright leds

**72282**

D/Blister  10 / 100



**FUTUR-LED II SERIE 12V - 2X16 LEDS**  
Coppia luci ultrasottili a led. Flessibili, retro adesivo 3M®. Omologazione europea, lente neutra con luce arancio

**FUTUR-LED II SERIE 12V - 2X16 LEDS**  
Adhesive flexible lights with super-bright leds. Approved

**72284**

Blister Sfil.  10 / 60



**SIDE-MARKER 3 - 12V**  
Luci laterali ausiliarie con 3 diodi luminosi arancio (Led). Impermeabili, cavo da 5 m. Adesivo 3M®

**SIDE-MARKER 3 - 12V**  
Side marker amber led lights. 3M® adhesive

**72288**

D/Blister  10 / 50

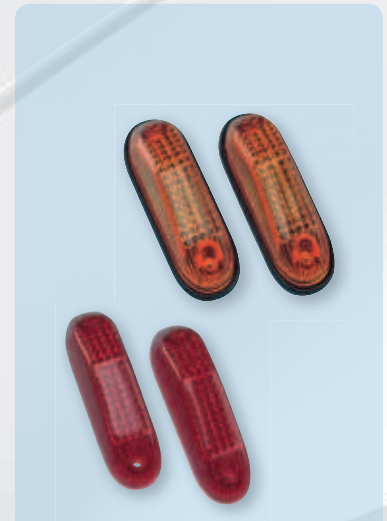

**COPPIA MICRO-FRECCE 12V**  
Con lenti intercambiabili di colore rosso e arancione.

**MICRO-LIGHTS 12V (PAIR)**  
With interchangeable red and amber lenses.

**70216**

Blister  12 / 288



**E** 5 LAMPADE

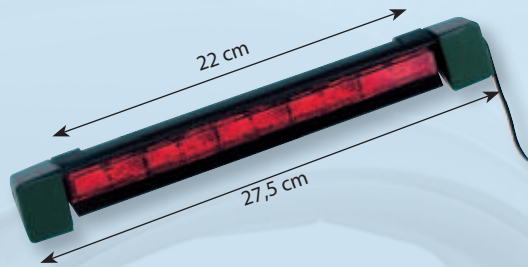

**SLIM-STOP 5, 12V**  
Stop supplementare a 5 lampade, omologato

**SLIM-STOP 5, 12V**  
5 Bulbs third brake light, european approved

**70230**

D/blister 12 / 48



**E** 7 LAMPADE



**SLIM-STOP 7, 12V**  
Stop supplementare a 7 lampade, omologato

**SLIM-STOP 7, 12V**  
7 Bulbs third brake light, european approved

**70231**

D/blister 12 / 48



**E** 35 LED

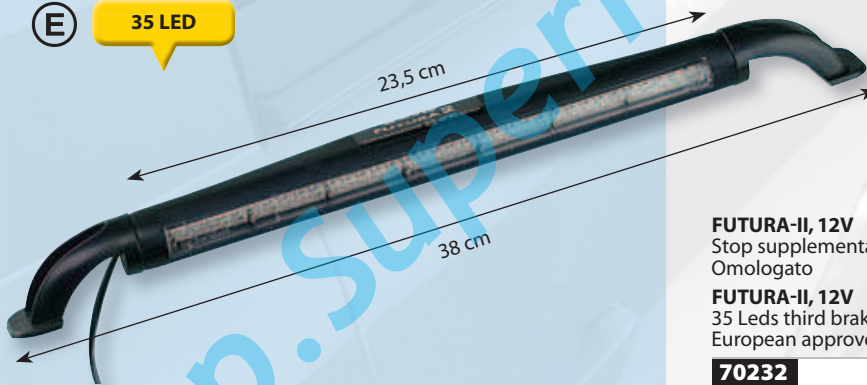

**FUTURA-II, 12V**  
Stop supplementare a 35 leds. Omologato

**FUTURA-II, 12V**  
35 Leds third brake light. European approved

**70232**

D/blister 10 / 50



eshop.SuperRaceTuning.eu



**FARO POSTERIORE AUSILIARIO 12V**

Usò retronebbia o stop  
Lampadine incluse (1x): P21W  
Omologazione Europea

**AUXILIARY REAR LIGHT 12V**

Fog, brake use  
Bulbs included (1x): P21W  
ECE approval

**41501**

D/Blister 10 / 20

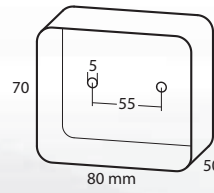

LAMPADINE  
INCLUDE  
BULBS INCLUDED



**BASIC, FANALE POSTERIORE  
3 FUNZIONI 12V**

Posizione, stop, direzione.  
Lampadine incluse (1x): P21W, P21/5W  
Omologazione Europea

**BASIC, 3 FUNCTIONS TAIL LIGHT 12V**

Blinker, parking, brake light  
Bulbs included (1x): P21W, P21/5W.  
ECE approval

**41505**

D/Blister 10 / 20

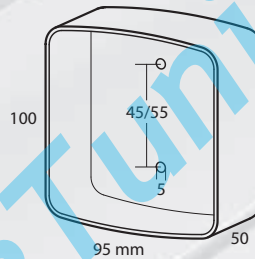

LAMPADINE  
INCLUDE  
BULBS INCLUDED



**BASIC, FANALE POSTERIORE  
4 FUNZIONI 12V**

Posizione, stop, direzione, luce targa.  
Omologazione Europea

Lampadine incluse (1x): P21W, P21/5W

**BASIC, 4 FUNCTIONS TAIL LIGHT 12V**  
Blinker, parking, brake, plate light. ECE  
approval

Bulbs included (1x): P21W, P21/5W

**41506**

D/Blister 10 / 20

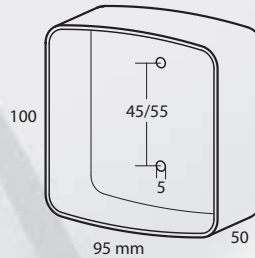

LAMPADINE  
INCLUDE  
BULBS INCLUDED



**FANALE ILLUMINAZIONE TARGA 12V**

Lampadine incluse (1x): C5W  
Omologazione Europea

**LICENCE PLATE LAMP 12V**

Bulbs included (1x): C5W  
ECE approval

**41502**

D/Blister 10 / 40

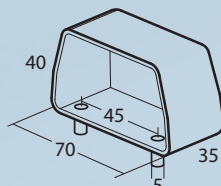

LAMPADINE  
INCLUDE  
BULBS INCLUDED

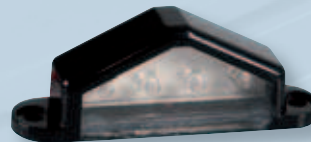

**FANALE LED ILLUMINAZIONE  
TARGA 12/24V**

4 Led bianchi. Impermeabile.  
Adatto anche come luce  
ingombro

**LICENCE PLATE  
LED LAMP 12/24V**

4 white Led. Waterproof.  
Suitable also as side light

**98475**

D/Blister 10 / 50

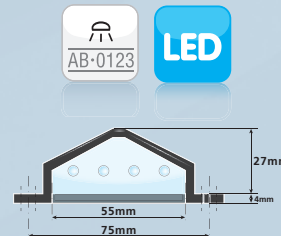



**EUROPA, FANALE POSTERIORE 6 FUNZIONI 12V**  
 Omologazione Europea. Catarifrangente classe IA.  
 Lampadine incluse (1x): P21W, P21/5W, PY21W, C5W  
**EUROPA, 6 FUNCTIONS TAIL LIGHT 12V**  
 ECE approval. Class IA reflector  
 Bulbs included (1x): P21W, P21/5W, PY21W, C5W

- 41507** Destro / Right
- 41508** Sinistro / Left

D/Blister 5 / 10

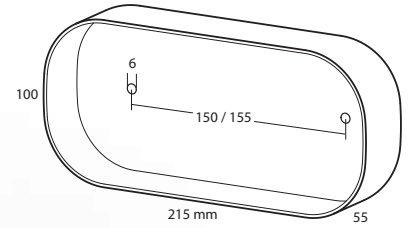

LAMPADINE  
 INCLUDE  
 BULBS INCLUDED



**Sinistro  
 Left**



**Destro  
 Right**

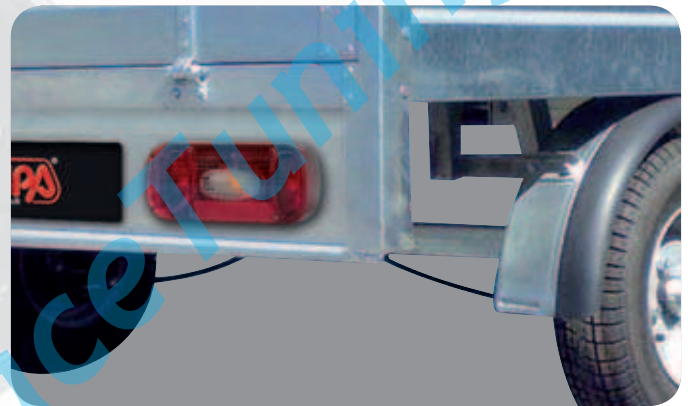

**DELUXE, FANALE POSTERIORE 8 FUNZIONI 12V**  
 Omologazione Europea  
 Lampadine incluse (2x): P21W, P21/5W  
**DELUXE, 8 FUNCTIONS TAIL LIGHT 12V**  
 ECE approval  
 Bulbs included (2x): P21W, P21/5W

- 41510** Destro / Right
- 41511** Sinistro / Left

D/Blister 5 / 10

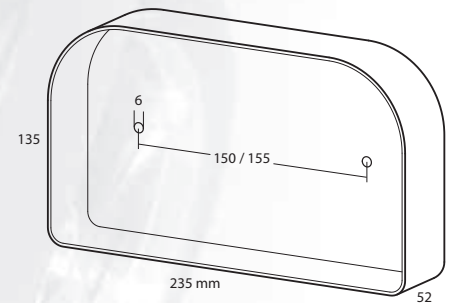

LAMPADINE  
 INCLUDE  
 BULBS INCLUDED



**Sinistro  
 Left**



**Destro  
 Right**



Prese ad  
 innesto rapido  
 incluse

Quick  
 connection  
 sockets  
 included





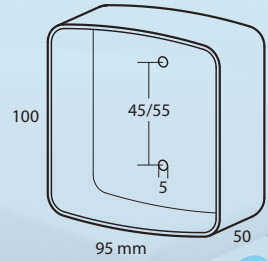

**KIT**

LAMPADINE INCLUDE BULBS INCLUDED



AB-0123

**PRONTO-FARI, KIT DI SEGNALAZIONE POSTERIORE, 12V**

- Omologazione Europea. Kit cablato e montato pronto per l'utilizzo, composto da:
- 2 fanali posteriori a 4 funzioni: posizione, stop, direzione, targa
  - 2,5 m cavo di collegamento tra i due fanali
  - 7,5m di cablaggio
  - Spinotto 7 poli
  - Lampadine incluse (1x): P21W, P21/5W

**PRONTO-FARI, PRE-WIRED TRAILER LIGHTS WIRING SET, 12V**

- ECE approval
- 2 tail lights.
  - 4 functions: blinker, driving, brake, licence plate lights
  - 2,5 m jumper cable between 2 lamps
  - 7,5 m power cable
  - 7 pin plug
  - Bulbs included (1x): P21W, P21/5W

**41516**

D/Blister 5 / 10



**MAGNETIC**

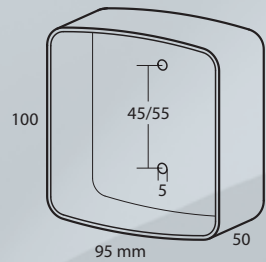

**KIT**

LAMPADINE INCLUDE BULBS INCLUDED



AB-0123

**PRONTO-FARI, KIT DI SEGNALAZIONE POSTERIORE MAGNETICO, 12V**

- Omologazione Europea. Con base magnetica per un fissaggio rapido e universale su qualsiasi superficie metallica. Kit cablato e montato pronto per l'utilizzo, composto da:

- 2 fanali posteriori a 4 funzioni: posizione, stop, direzione, targa
- 2,5 m cavo di collegamento tra i due fanali
- 7,5m di cablaggio
- Spinotto 7 poli
- Lampadine incluse (1x): P21W, P21/5W

**PRONTO-FARI, MAGNETIC PRE-WIRED TRAILER LIGHTS WIRING SET, 12V**

- ECE approval
- 2 magnetic tail lights.
  - 4 functions: blinker, driving, brake, licence plate lights
  - 2,5 m jumper cable between 2 lamps
  - 7,5 m power cable
  - 7 pin plug
  - Bulbs included (1x): P21W, P21/5W

**41517**

D/Blister 5 / 10





**LAMPADINE  
INCLUDE  
BULBS INCLUDED**



**BARRA PER SEGNALETICA  
POSTERIORE 12V**

Portatarga completa di fanali,  
lampadine, catarifrangenti e cavo  
con spinotto 7 poli. Cavo 6 m.  
Omologazione Europea

**REAR TRAILER BOARD 12V**

Number plate holder equipped with  
lights, bulbs, reflectors, cable and 7  
pin plug. 6 m cable. ECE approval

**41520** 120x14 cm

Cartone / Carton  5

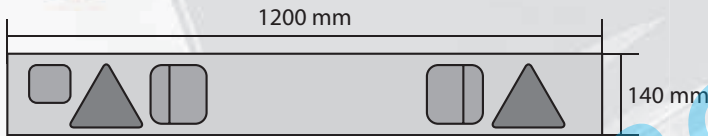
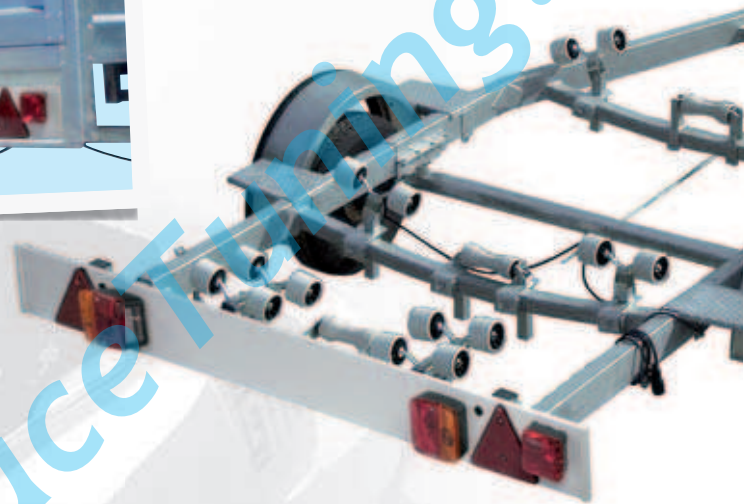
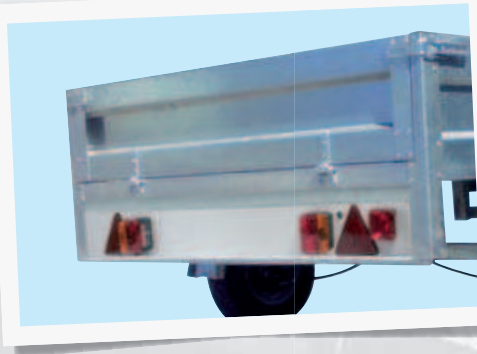

**LAMPADINE  
INCLUDE  
BULBS INCLUDED**



**BARRA ESTENSIBILE IN METALLO PER  
SEGNALETICA POSTERIORE, 12V**

Completa di fanali, lampadine,  
catarifrangenti, portatarga e cavo con  
spinotto 7 poli. Cavo 7,5 m. Omologazione  
Europea

**TELESCOPIC REAR TRAILER BOARD, 12V**

Equipped with lights, bulbs, reflectors,  
cable, number plate holder and 7 pin  
plug. 7,5 m cable. ECE approval

**41521** 100>160 cm

Cartone / Carton  5



**Telescopico  
Telescopic**

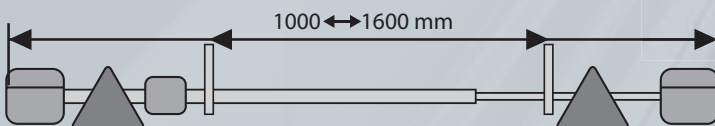



**SPINOTTO 7 POLI, CHIUSURA AUTOBLOCCANTE**  
Fermacavo con chiusura autobloccante  
**7 POLES PLUG, AUTOLOCK TYPE**

**38980**

D/Blister 10 / 50



**PRESA 7 POLI CON CABLAGGIO DA 160 CM**  
Adatta per art. 38980 e 38981  
**7 POLES SOCKET, WITH 160 CM CABLE**  
Suitable for art. 38980 - 38981

**38987**

D/Blister 5 / 20



**SPINOTTO 7 POLI, CHIUSURA A VITE**  
Fermacavo con chiusura a vite  
**7 POLES PLUG, SCREW-LOCK TYPE**

**38981**

D/Blister 10 / 50



**PRESA 7 POLI**  
adatta per art. 38980 e 38981  
**7 POLES SOCKET**  
suitable for art. 38980 - 38981

**38985**

D/Blister 10 / 50



**SPINOTTO 13 POLI**  
Con bloccaggio a vite  
**13 POLES PLUG**  
Screw-lock type

**38982**

D/Blister 10 / 50



**PRESA 13 POLI**  
Adatta per art. 38982  
**13 POLES SOCKET**  
Suitable for art. 38982

**38986**

D/Blister 10 / 50



**ADATTATORE 13<->7 POLI**  
13 poli maschio <->  
7 poli femmina  
**13<->7 POLES ADAPTER**  
13 poles male <->  
7 poles female socket

**38990**

D/Blister 10 / 50



**ADATTATORE 13<->7 POLI,  
CON CABLAGGIO DA 40 CM.**  
13 poli maschio <-> 7 poli femmina  
**13<->7 POLES ADAPTER, WITH 40  
CM CABLE**  
13 poles (male) <-> 7 poles (female)  
socket

**38991**

D/Blister 5 / 20



**ADATTATORE 7<->13 POLI CON  
CABLAGGIO DA 40 CM**  
7 poli maschio <-> 13 poli femmina  
**7<->13 POLES ADAPTER WITH 40  
CM CABLE**  
7 poles male <-> 13 poles female  
socket

**38992**

D/Blister 5 / 20



**ADATTATORE 7<->13 POLI**  
7 poli maschio <-> 13 poli femmina  
**7<->13 POLES ADAPTER**  
7 poles male <-> 13 poles female  
socket

**38993**

D/Blister 10 / 50



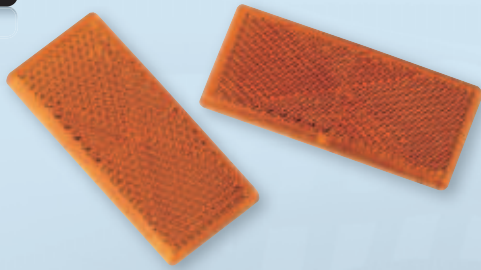

**CATARIFRANGENTI RETTANGOLARI**

2 pezzi, adesivi, uso laterale

**RECTANGULAR REFLECTORS**

2 pcs, adhesive, side use

**20532** Arancio Amber 80x36 mm

Blister 48 / 432

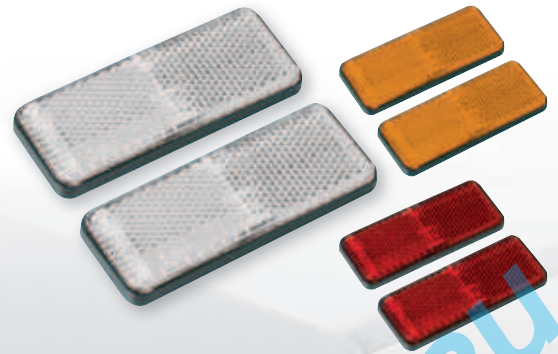

**EURO-NORM, CATARIFRANGENTI RETTANGOLARI**

2 pezzi. Omologati a norme europee

**EURO-NORM, RECTANGULAR REFLECTORS**

2 pcs. E-mark approved

**20539** Bianco White

**20540** Rosso Red 90x35 mm

**20541** Arancio Amber

D/Blister 10 / 50



**EURO-NORM CATARIFRANGENTI TRIANGOLARI**

2 pezzi, omologati a norme europee

**EURO-NORM TRIANGULAR REFLECTORS**

2 pcs, E-mark approved

**20542** Rosso Red 160 mm

D/Blister 10 / 50



**EURO-NORM CATARIFRANGENTI TRIANGOLARI**

2 pezzi

**EURO-NORM TRIANGULAR REFLECTORS**

2 pcs

**20543** Arancio Amber 160 mm

Blister Sfil. 10 / 100



**EURO-NORM, CATARIFRANGENTI ROTONDI**

2 pezzi. Omologati a norme europee

**EURO-NORM, ROUND REFLECTORS**

2 pcs. E-mark approved

**20544** Bianco White

**20545** Arancio Amber Ø 65 mm

**20546** Rosso Red

D/Blister 10 / 50

