



Portaggio

Roof Racks

Fissaggio bagagli	676	Luggage fixing
Barre portatutto	679	Roof bars
Linea Professionale	682	Professional Line
Portasci	688	Ski carriers
Box tetto	692	Roof boxes
Portabiciclette	696	Bicycle carriers





CORDA ELASTICA RAGNO 8 GANCI Ø 10 MM
 Con anello di raccordo. 8 braccia da 40 cm.
 Ganci in acciaio temperato antirottura con
 plastificazione superficiale. Omologata GS-TÜV
SPIDER ELASTIC CORDS, 8 ARMS Ø 10 MM
 With connection ring. 8 arms of 40 cm. High-
 tensile heat-treated metal hooks with plastic
 coating. GS-TÜV approved

60310

Busta / Bag 10 / 30

SPIDER-NET RETE ELASTICIZZATA MULTIUSO
 adatta per svariati utilizzi, tipo: fissare il carico sul
 portapacchi, ancorare gli oggetti nel baule, rete
 divisoria, rete fermacarico, rete fermacani
 Ø 4,5 mm - cm 90x120, 12 ganci - Maglie da 10 cm

SPIDER-NET MULTIPURPOSE ELASTIC NET
 May be used as roof-rack net, trunk net, dog/cargo net...
 Ø 4,5 mm, size cm 90x120, 12 hooks, 10 cm mesh

60261

D/B blister 12 / 24



CORDE ELASTICHE STANDARD Ø 10 MM
 In lattice di gomma multifilare con
 rivestimento in nylon. Ganci in acciaio
 temperato con plastificazione superficiale e
 tappi antigraffio. Omologate GS-TÜV

STANDARD ELASTIC CORDS Ø 10 MM
 Latex straps with nylon PP webbing.
 Hardened metal hooks with epoxy coating
 and anti-scratch caps. GS-TÜV approved

60182	2x60 cm	Busta / Bag	10 / 60
60192	2x80 cm	Busta / Bag	10 / 50
60202	2x100 cm	Busta / Bag	10 / 40
60212	2x150 cm	Busta / Bag	10 / 30
60222	2x200 cm	Busta / Bag	10 / 20



X-POWER, NASTRO ELASTICIZZATO
 Ad alta tensione: 3 volte piu forte delle
 corde elastiche tradizionali. Gancio in acciaio
 temperato a sezione maggiorata 4 mm, con
 plastificazione PP superficiale, non si piega,
 non graffia, non arrugginisce

X-POWER, HEAVY DUTY STRETCH CORD
 High-tensile, 3x stronger than conventional
 cords. 4 mm coated steel hooks, won't bend,
 break, scratch or mark

60183	60 cm	D/B blister	10 / 100
60193	80 cm	D/B blister	10 / 100
60203	100 cm	D/B blister	10 / 100
60213	150 cm	D/B blister	10 / 50
60223	200 cm	D/B blister	10 / 50

D/B blister 10 / 100

Trazione massima
25 N (25 Kg)

18 mm



NASTRO TENSORE CM 500
Fibbia di arresto con molla a chiusura ed apertura rapida.

500 CM TIE DOWN STRAP

60160

D/Blister 12 / 24



SET 2 NASTRI TENSORI CM 250
Fibbia di arresto con molla a chiusura ed apertura rapida.

SET 2 X 250 CM TIE DOWN STRAPS

60150

D/Blister 12 / 24



NASTRO TENSORE CON CRICCHETTO CM 500

500 CM RATCHET TIE DOWN STRAP

60161

D/Blister 12 / 24



NASTRO TENSORE CON CRICCHETTO CM 450+50
Con cricchetto in acciaio e 2 ganci ad "S" in acciaio plastificato.

450+50 CM RATCHET TIE DOWN STRAP
With two "S" hooks.

60162

D/Blister 12 / 24



NASTRO TENSORE CM 500+20
Con fibbia di bloccaggio rapido e 2 ganci ad "S" in acciaio plastificato.

500+20 CM TIE DOWN STRAP
With two "S" hooks.

60159

D/Blister 12 / 24





125 daN

PRO-SAFE, SET 2 NASTRI TENSORI CON CRICCHETTO A DOPPIO GANCIO "S" CM 500
Larghezza nastro 2,5 cm, 125 daN. Cricchetto con impugnature gommata. Ganci plastificati. Nastro in PP per fissare, legare o ancorare gli oggetti trasportati

PRO-SAFE, HEAVY DUTY RATCHET TIE-DOWN STRAPS SET CM 500
Width strap cm 2,5, 125 daN. Rubber grip ratchet. Plastic coated hooks for the secure fastening of transported cargo

60166

Cavaliere / Header 12



400 daN

PRO-SAFE, SET 2 NASTRI TENSORI CON CRICCHETTO A DOPPIO GANCIO CM 500
Larghezza nastro 3,5 cm, 400 daN. Cricchetto con impugnature gommata. Ganci plastificati. Nastro in PP per fissare, legare o ancorare gli oggetti trasportati

PRO-SAFE, HEAVY DUTY RATCHET TIE-DOWN STRAPS SET
Width strap cm 3,5, 400 daN. Rubber grip ratchet. Plastic coated hooks for the secure fastening of transported cargo

60167

Cavaliere / Header 6

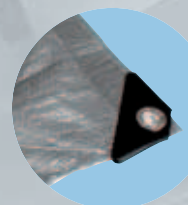
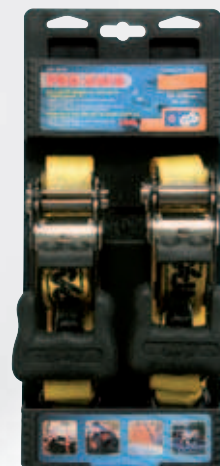

Angolari in plastica
Plastic angulars

TELO IMPERMEABILE IN POLIETILENE
Laminato su ambo i lati, antistrappo, lavabile e ripiegabile. Con ugelli in metallo e angolari in plastica. Bordi rinforzati con corda interna. Resistente ai raggi UV.

POLYETHYLENE TARPULIN
Washable, metal eyelets, plastic angulars, mildew proof, laminated woven, reinforced edges, UV stabilised

20510	2x2 m	Borsina / Bag	10
20511	3x4 m	Borsina / Bag	8
20512	4x5 m	Borsina / Bag	8
20513	6x8 m	Borsina / Bag	3

Rail-Top

Acciaio / Steel
max 75 kg



RAIL-TOP, BARRE PORTATUTTO IN ACCIAIO

Omologate TÜV, portata max 75 kg.
Per veicoli equipaggiati con mancorrente.
Tubo in acciaio ad alta resistenza con
plastificazione anti-corrosione.
Montaggio rapido.

RAIL-TOP, STEEL ROOF BAR

TÜV approved, max load 75 kg.
For fitting on vehicles equipped with
original roof rails.
Heavy duty high resistant steel tubes
with anti-corrosion coating.
Quick-fit.

22500	110 cm
22502	120 cm
22503	135 cm

Busta + Cartoncino / Bag+Card 4



Rail-Pro

Alluminio
max 60 kg

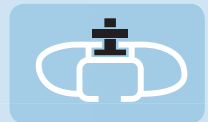

RAIL-PRO, BARRE PORTATUTTO IN ALLUMINIO

Omologate TÜV, portata max 60 kg.
Per veicoli equipaggiati con mancorrente.
Tubo in alluminio anodizzato a sezione
maggiorata.
Guida centrale con superficie appoggio in
gomma EPDM, predisposta per l'inserimento
diretto dei vari accessori.
Montaggio rapido

RAIL-PRO, ALUMINIUM ROOF BAR

TÜV approved, max load 60 kg.
For fitting on vehicles equipped with
original roof rails.
Heavy duty high resistant aluminium bars
with EPDM padded central slide suitable
for "T" adapters roof accessories.
Quick-fit

22507	110 cm
22505	120 cm
22506	135 cm

Busta + Cartoncino / Bag+Card 4





RAIL-TOP, RAIL-PRO distinta applicazione | RAIL-TOP, RAIL-PRO fitting chart

Marca e modello	Allestimento	Anno	Misura
ALFA ROMEO			
159	5p. SW	06-->	120 cm
156 Crosswagon	5p. SW	04-->	120 cm
156 Sportswagon	5p. SW	00-->	120 cm
AUDI			
80	5p. Avant	92-->95	110 cm
100	5p. Avant	83-->94	120 cm
200	5p. Avant	83-->90	120 cm
A4	5p. Avant	96-->05	120 cm
A6	5p. Avant	94-->04	120 cm
A6 Allroad	5p. Avant	00-->04	120 cm
A6 Allroad	5p.	06-->	135 cm
BMW			
3-serie	5p. Touring	96-->	120 cm
5-serie	5p. Touring	01-->	120 cm
5-serie	5p. Touring	97-->00	120 cm
X3	5p.	03-->	135 cm
X5	5p.	00-->	135 cm
CHEVROLET			
Captiva	5p.	06-->	120 cm
Lacetti SW	5p.	04-->	110 cm
Matiz (Mk. I)	5p.	-->05	110 cm
Matiz (Mk. II)	5p.	06-->	110 cm
Nubira III	5p. SW	04-->	110 cm
Tacuma	5p. SW	05-->	110 cm
Thaoe	5p. SUV	00-->	135 cm
Trans Sport 4/5-p	MPV	97-->	120 cm
CHRYSLER			
300C	5p. SW	04-->	120 cm
Grand Voyager	5p. MPV	96-->00	120 cm
CITROËN			
Berlingo Family	4p.	03-->	110 cm
Berlingo Top	5p. MPV	01-->	110 cm
BX	5p. SW	89-->94	120 cm
C3 X-TR	5p. MPV	04-->	135 cm
C4 Picasso	5p. MPV	07-->	135 cm
C5	5p. SW	01-->	120 cm
C-crosser	5p.	07-->	135 cm
XM	5p. SW	90-->00	120 cm
ZX	5p. SW	92-->98	120 cm
DACIA			
Logan	5p.	07-->	110 cm
DAEWOO			
Matiz	5p.	01-->	110 cm
Nubira	5p. SW	97-->	110 cm
Tacuma	5p. SW	00-->	110 cm
DAIHATSU			
Feroza	3p.	88-->99	110 cm
Terios	5p.	05-->	135 cm
FIAT			
Croma	5p.	05-->	120 cm
Doblò Malibù	3/5p. Van	00-->	135 cm
Idea	5p.	03-->	120 cm
Marea	5p. SW	96-->03	110 cm
Palio	5p. SW	97-->	110 cm
Panda	5p.	03-->	120 cm
Panda	5p. 4x4	04-->	120 cm
Panda	3p. 4x4	83-->02	120 cm
Sedici		06-->	135 cm
Stilo Multiwagon	5p. SW	03-->	135 cm
Stilo Uproad	5p. SW	05-->	135 cm
Strada	2p.	04-->	110 cm
Tempra	5p. SW	89-->98	110 cm
Uno	5p.	84-->98	110 cm
FORD			
Escort	5p. SW	91-->99	110 cm
Focus	5p. SW	98-->	110 cm
Galaxy	5p. MPV	95-->	135 cm
Mondeo	5p. SW	01-->	120 cm
Mondeo	5p.	93-->00	110 cm
Scorpio	5p. SW	85-->94	110 cm
Sierra	5p. SW	83-->94	110 cm

Marca e modello	Allestimento	Anno	Misura
HONDA			
Accord Aerodeck	5p. SW	98-->03	120 cm
Accord Tourer	5p. SW	03-->	120 cm
Accord wagon	5p.	94-->97	110 cm
Accord wagon	5p.	98-->02	120 cm
Civic	5p. SW	97-->	110 cm
Civic Shuttle	5p. MPV	88-->	120 cm
CR-V	5p.	96-->01	120 cm
Odyssey	5p. MPV	03-->	135 cm
HYUNDAI			
Atos	5p.	98-->	110 cm
Getz Cross	5p.	06-->	110 cm
H-1		97-->	110 cm
Lantra	5p. SW	96-->	110 cm
Matrix	5p. MPV	01-->	110 cm
Santa Fé	5p.	00-->	120 cm
Starex	4p. MPV	97-->	110 cm
Terracan	5p.	01-->	135 cm
Trajet	5p. SW	00-->	120 cm
Tucson	5p. Suv	04-->	120 cm
ISUZU			
Trooper	3/5 p.	99-->	135 cm
JAGUAR			
X-type	5p. SW	03-->	120 cm
JEEP			
Cherokee	5p.	02-->	120 cm
Cherokee Renegade	5p.	05-->	120 cm
Grand Cherokee	5p.	02-->	135 cm
Grand Cherokee	5p.	92-->	120 cm
Grand Cherokee Limited	5p.	05-->	135 cm
Grand Cherokee Vision	5p.	05-->	120 cm
KIA			
Carens	5p.	02-->	110 cm
Carnival	5p.	06-->	120 cm
Carnival	4p. MPV	98-->01	120 cm
Carnival II	5p. MPV	02-->	120 cm
Cee'd	5p. SW	07-->	120 cm
Grand Carnival	5p.	06-->	120 cm
Rio	5p. SW	02-->	110 cm
Sorento	5p.	02-->	120 cm
Sorento	5p.	07-->	120 cm
Sportage	3/5p.	96-->	120 cm
LADA			
111	5p. SW	98-->	110 cm
LANCIA			
Lybra	5p. SW	00-->	120 cm
LAND ROVER			
Discovery	5p.	04-->	135 cm
Discovery	5p.	96-->03	135 cm
Freelander	5p.	98-->	110 cm
LEXUS			
RX (Mk II)	5p.	03-->	120 cm
MAZDA			
5	5p. MPV	05-->	120 cm
6	5p. SW	02-->04	120 cm
6	5p. SW	06-->	120 cm
626	5p. SW	88-->02	120 cm
Demio	5p. MPV	96-->	120 cm
MPV	5p.	97-->03	120 cm
Premacy	5p. MPV	98-->02	120 cm
MERCEDES			
Classe C (W202)	5p. SW	93-->00	120 cm
Classe C (W203)	5p. SW	01-->	120 cm
Classe E (W124)	5p. SW	85-->95	120 cm
Classe E (W210)	5p. SW	96-->02	120 cm
Classe E (W211)	5p. SW	03-->	135 cm
Classe GL	5p.	06-->	135 cm
Classe M (W163)	5p.	98-->	135 cm
Classe M (W164)	5p.	06-->	135 cm
Vaneo	5p.	02-->	135 cm
MG			
ZT-T	5p. SW	02-->	120 cm



RAIL-TOP, RAIL-PRO distinta applicazione | RAIL-TOP, RAIL-PRO fitting chart

Marca e modello	Allestimento	Anno	Misura
MITSUBISHI			
Grandis	5p.	03-->	120 cm
Outlander	5p. SUV	03-->05	120 cm
Outlander (Mk II)	5p. SUV	05-->06	135 cm
Pajero	3p.	91-->	135 cm
Pajero	5p.	91-->98	120 cm
Pajero	5p.	99-->	135 cm
Pajero Pinin	5p.	00-->	120 cm
Pajero Pinin	3p.	99-->	120 cm
Pajero Sport	5p.	00-->	120 cm
Space Runner	5p. MPV	92-->	120 cm
Space Star	5p. MPV	98-->	120 cm
Space Wagon	3p. MPV	84-->98	120 cm
Space Wagon	3p. MPV	99-->	120 cm
NISSAN			
Almera	5p. SW	99-->	120 cm
Murano	5p.	03-->	135 cm
Navara	4p.	04-->	120 cm
Pathfinder (R51)	5p. SUV	05-->	120 cm
Patrol GR	5p.	98-->	135 cm
Primera (W10)	5p. SW	91-->97	120 cm
Primera (W11)	5p. SW	98-->01	120 cm
Primera (W12)	5p. SW	02-->	120 cm
Terrano (WD21)	3/5p.	86-->96	120 cm
Terrano II (R20)	3/5p.	93-->	120 cm
X-trail	5p. SUV	04-->	120 cm
OPEL			
Agila	5p. MPV	00-->	120 cm
Antara	5p.	07-->	120 cm
Astra	5p. SW	92-->97	120 cm
Astra	5p. SW	98-->03	120 cm
Frontera	5p.	92-->	120 cm
Frontera Sport	3p.	92-->	120 cm
Kadett	5p. SW	85-->91	110 cm
Omega	5p. SW	86-->93	120 cm
Omega	5p. SW	94-->03	120 cm
Sintra	4/5p. MPV	96-->	120 cm
Vectra	5p. SW	96-->02	110 cm
Zafira	5p. MPV	98-->04	120 cm
PEUGEOT			
306	5p. SW	97-->01	110 cm
307	5p. SW	02-->	120 cm
405	5p. SW	89-->97	110 cm
406	5p. SW	97-->04	110 cm
407	5p. SW	04-->	120 cm
1007	5p.	05-->	135 cm
4007	5p.	05-->	135 cm
206 SW	5p. SW	02-->	120 cm
Ranch		01-->	110 cm
PONTIAC			
Trans Sport	4/5p. MPV	98-->	120 cm
PORSCHE			
Cayenne	5p.	03-->	120 cm
RENAULT			
Kangoo	5p. Van	03-->	110 cm
Laguna I	5p. SW	96-->00	120 cm
Laguna II	5p. SW	01-->	120 cm
Mégane	5p. SW	03-->	120 cm
ROVER			
75	5p. SW	01-->	110 cm
Streetwise	3/5p.	04-->	110 cm
SAAB			
9-3	5p. SW	05-->	120 cm
9-5	5p. SW	99-->	135 cm
9-7X	5p. SUV	04-->	120 cm
SEAT			
Alhambra	5p. MPV	96-->	135 cm
SKODA			
Fabia	5p. SW	00-->	110 cm
Felicia	5p. SW	96-->	110 cm
Octavia I	5p. SW	98-->04	120 cm
Octavia II	5p. SW	05-->	120 cm

Marca e modello	Allestimento	Anno	Misura
Octavia Scout	5p. SW	07-->	120 cm
Roomster	5p.	06-->	120 cm
SSANGYONG			
Korando	3p.	97-->	120 cm
Kyron	5p.	06-->	135 cm
Musso	5p.	96-->	135 cm
Rexton	5p.	00-->	120 cm
Rodius	5p.	04-->	120 cm
SUBARU			
Impreza	5p. SW	93-->	110 cm
Justy	5p.	03-->	120 cm
Legacy	5p. SW	89-->	110 cm
Outback	5p. SW	97-->02	110 cm
SUZUKI			
Baleno	5p. SW	96-->02	110 cm
Grand Vitara	3/5p.	98-->04	120 cm
Ignis	5p.	01-->	120 cm
Jimny	3p.	98-->	120 cm
SX 4	5p.	06-->	135 cm
Vitara	5p.	99-->	120 cm
Wagon R	5p. MPV	99-->	110 cm
Wagon R+	5p. MPV	97-->	120 cm
TATA			
Indigo	5p. SUV	04-->	110 cm
TOYOTA			
4 Runner	5p.	90-->95	110 cm
Avensis	5p. SW	98-->	120 cm
Avensis Verso	5p. MPV	01-->	110 cm
Carina E	5p. SW	93-->97	110 cm
Carina II	5p. SW	88-->91	110 cm
Corolla	5p. SW	93-->97	120 cm
Corolla Verso	5p. MPV	02-->	135 cm
Land Cruiser	5p.	03-->	120 cm
Land Cruiser	3p.	03-->	135 cm
Land Cruiser 100	5p.	90-->	135 cm
Land Cruiser 500	5p.	05-->	135 cm
PicNic	5p. MPV	97-->	120 cm
Previa	5p. MPV	90-->	120 cm
RAV 4	3/5p.	00-->	120 cm
Yaris	3/5p.	99-->	120 cm
Yaris Verso	5p. MPV	00-->	110 cm
VOLKSWAGEN			
Bora	5p. Variant	99-->05	110 cm
Cross Golf	5p.	07-->	120 cm
Cross Polo	5p.	06-->	110 cm
Golf III	5p. Variant	94-->98	110 cm
Golf IV	5p. Variant	99-->	120 cm
Passat	5p. Variant	06-->	120 cm
Passat	5p. Variant	83-->05	120 cm
Polo Fun	5p.	03-->	110 cm
Sharan	5p. MPV	96-->	135 cm
Touareg	5p.	05-->	120 cm
Touran	5p. MPV	03-->	135 cm
VOLVO			
740	5p. SW	84-->92	120 cm
760	5p. SW	82-->90	120 cm
850	5p. SW	93-->96	135 cm
940/960	5p. SW	91-->98	120 cm
V40	5p. SW	96-->03	120 cm
V50	5p. SW	04-->	120 cm
V50	5p. SW	04-->	135 cm
V70	5p. SW	97-->	135 cm
V90	5p. SW	97-->98	120 cm
XC 70	5p. SW	98-->	135 cm
XC 90	5p.	02-->	120 cm



Kargo System

È il sistema di portaggio appositamente realizzato per i veicoli commerciali. Sicurezza, robustezza, versatilità, funzionalità ed eleganza solo le caratteristiche che contraddistinguono questa linea di portaggio per uso professionale. Il sistema è costituito da 2 versioni di barre da abbinare ad una serie di kit di fissaggio, specifici per ogni veicolo.

*It's a carrying solution specifically designed for commercial vehicles.
Safety, versatility, sturdiness and elegance are the features of this system.
The system consists of 2 series of bars to be combined
with various fitting kits, custom-made to fit every specific van.*



NORDRIVE[®]
TRANSPORT SOLUTIONS

NORDRIVE[®]
TRANSPORT SOLUTIONS

Kargo

Barra in acciaio elettrozincato,
con guaina di rivestimento in PVC
Galvanized steel bar covered with PVC sheath

Kargo-Plus

Barra in alluminio anodizzato, dotata di 3 canaline predisposte per l'inserimento degli accessori tramite i connettori "T" unificati.

Nella canalina superiore **1** vi è inserito il profilo in gomma antiscivolo che funge da appoggio per il carico trasportato. All'interno si possono inserire i fermascale, gli anelli di ancoraggio ed altri accessori.

Anche nella canalina laterale **2** si possono inserire i vari fermascale, anelli di ancoraggio ed il kit rulliera.

La canalina inferiore **3** invece, è la predisposizione per l'inserimento del deflettore aerodinamico (optional in preparazione) che devia il flusso dell'aria tra il tetto del veicolo e le barre. In assenza del deflettore, la barra viene fornita con un profilo in gomma appositamente realizzato per migliorare l'aerodinamica.

*Anodised aluminium bar, equipped with 3 railings.
The top rail **1** contains the anti-slip rubber profile which contacts the transported cargo and it is used also for inserting the load stops, eye-bolts, or other accessories.
The side rail **2** is for inserting the roller, load stops and eye-bolts.*

*The lower rail **3** is used for the insertion of an adjustable wind deflector (under preparation) which deflects the airflow passing between the bars and the vehicle's roof. In absence of the deflector, the bar is equipped with a contoured rubber profile to optimize the aerodynamic of the bar.*

+

Kit di ancoraggio - Fitting kits

I kit di ancoraggio utilizzano le predisposizioni di ogni singolo modello di veicolo e sono composti da un tampone in appoggio specifico, che sostiene la base di supporto della barra. Funzionali, facili da installare, tutte le basi sono dotate di copertura con chiusura di sicurezza.

*The fitting kits use the vehicle's own fitting points.
Each fitting base lays on solid custom-shaped pad.
Easy to install, all the feet are equipped with safety lock.*

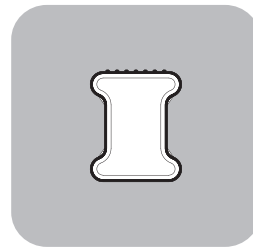

Kargo

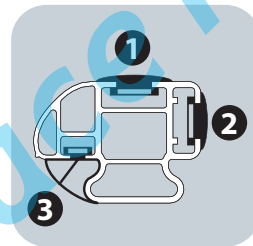

Kargo-Plus



Kargo

ACCIAIO / STEEL

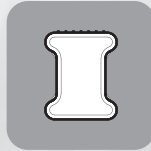

N10000	115 cm
N10005	135 cm
N10010	150 cm
N10015	180 cm

Scatola / Box  6

KARGO, BARRA PORTATUTTO IN ACCIAIO
Per veicoli commerciali.
Struttura in acciaio elettrozincato con guaina di rivestimento in pvc.

KARGO, STEEL ROOF BAR
For commercial vehicles.
Galvanized steel bar with pvc sheath

Optionals

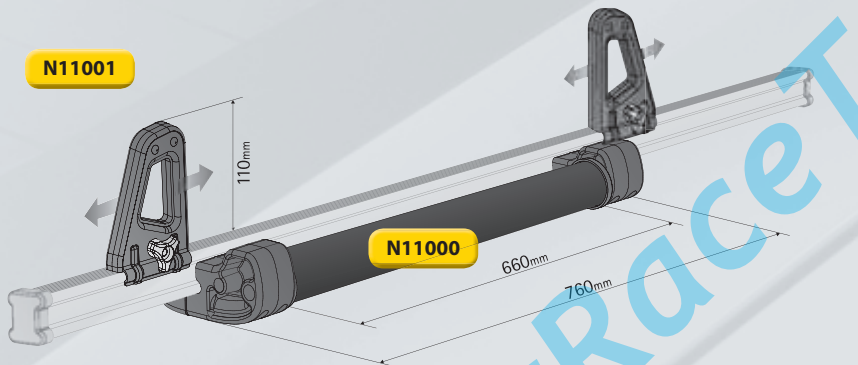

N11001

N11000

RULLO POSTERIORE K-0

In metallo con rivestimento plastico. Facilita il carico e lo scarico di oggetti lunghi, senza graffiarli

KARGO ROLLER K-0

Metal core with plastic sheath. Makes it easy to load up and download long objects from the rear of the vehicle.

N11000

Scatola / Box  4

FERMACARICO K-1 (COPPIA)

Scorrevoli lungo la barra e serrabili tramite pomello senza l'ausilio di utensili. Mantengono in posizione scale, tavole, assi ed altri carichi poco voluminosi.

LOAD STOPS K-1 (PAIR)

Easy to move along the bar and adjust according to the load. Keep the non-bulky load firmly in place and prevent it from sliding.

N11001

Scatola / Box  4 / 12

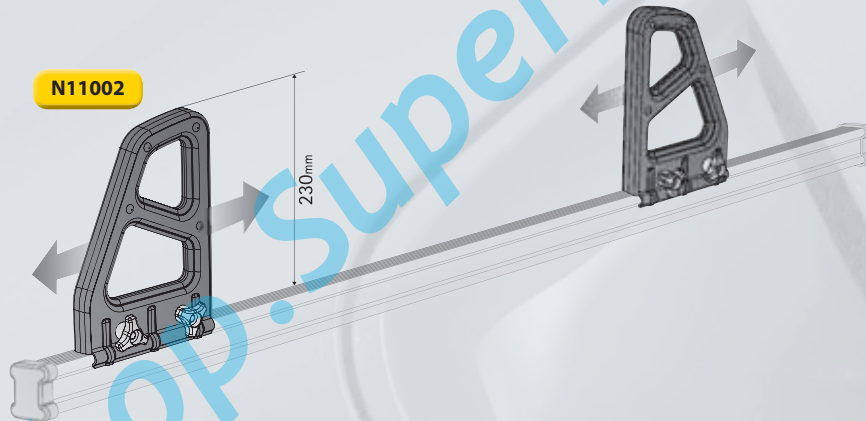

N11002

FERMACARICO K-2 (COPPIA)

Scorrevoli lungo la barra e serrabili tramite pomelli senza l'ausilio di utensili. Mantengono in posizione scale, tavole, assi ed altri carichi, anche voluminosi.

LOAD STOPS K-2 (PAIR)

Easy to move along the bar and adjust according to the load. Keep the bulky load firmly in place and prevent it from sliding.

N11002

Scatola / Box  4 / 12



Kargo-Plus

ALLUMINIO / ALUMINIUM

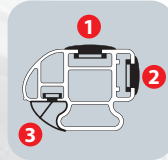

N10030	115 cm
N10035	135 cm
N10040	150 cm
N10045	180 cm

Scatola / Box  6

KARGO-PLUS, BARRA PORTATUTTO IN ALLUMINIO

Per veicoli commerciali.

Struttura in alluminio con 3 canaline di scorrimento a "T" unificate

KARGO-PLUS, ALUMINIUM ROOF BAR
Roof bar for commercial vehicles.
Aluminium with 3 "T" railings

Optionals

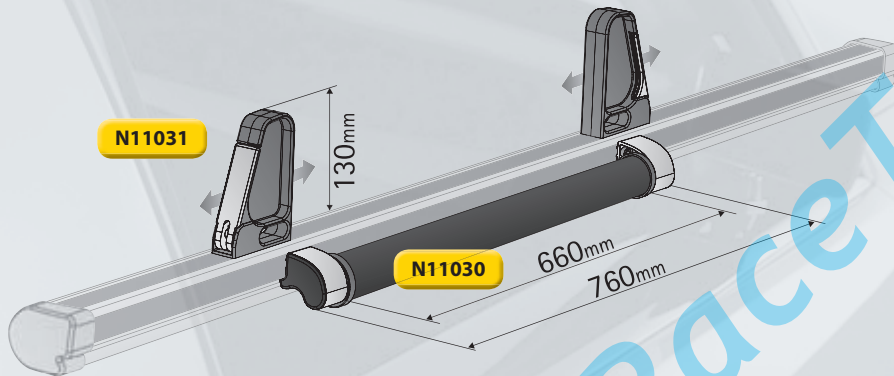

N11031

N11032



RULLO POSTERIORE KP-0

In metallo con rivestimento plastico. Facilita il carico e lo scarico di oggetti lunghi, senza graffiarli

KARGO ROLLER KP-0

Metal core with plastic sheath. Makes it easy to load up and download long objects from the rear of the vehicle.

N11030

Scatola / Box  4

FERMACARICO KP-1 (COPPIA)

Scorrevoli lungo la canalina-T superiore e serrabili tramite leva di bloccaggio rapido. Mantengono in posizione scale, tavole, assi ed altri carichi poco voluminosi.

LOAD STOPS KP-1 (PAIR)

Easy to move in the T-track along the bar and adjust according to the load. Keep the non-bulky load firmly in place and prevent it from sliding.

N11031

Scatola / Box  4 / 12

FERMACARICO KP-2 (COPPIA)

Ripiegabili quando non in uso, possono essere inseriti in entrambi le canaline-T (superiore o laterale) e scorrere lungo la barra. Serrabili tramite leva di bloccaggio rapido. Mantengono in posizione scale, tavole, assi ed altri carichi anche voluminosi.

LOAD STOPS KP-2 (PAIR)

Collapsible when not in use, may be used in both the top or side T-tracks.

Easy to move along the bar and adjust according to the load. Keep the bulky load firmly in place and prevent it from sliding.

N11032

Scatola / Box  4 / 12

OCCHIELLI DI FISSAGGIO KP-3 (COPPIA)

In acciaio. Si inseriscono nelle canaline-T. Permettono di assicurare il carico in modo semplice, veloce e sicuro. Da utilizzarsi in combinazione con nastri tensori.

EYE-BOLTS KP-3 (PAIR)

Steel made, may be used in the top or side T-tracks. To be used for securing the load, in combination with ratchet tie down.

N11033

Scatola / Box  10 / 100

Kit attacchi specifici - Fitting kits

Kargo



Kargo-Plus



I kit di ancoraggio utilizzano le predisposizioni di ogni singolo modello di veicolo e sono composti da tamponi in appoggio specifico, che sostengono le basi di supporto della barra. Funzionali, facili da installare, tutte le basi sono dotate di copertura con chiusura di sicurezza.

The fitting kits use the vehicle's own fitting points. Each fitting base lays on solid custom-shaped pad. Easy to install, all the feet are equipped with safety lock.

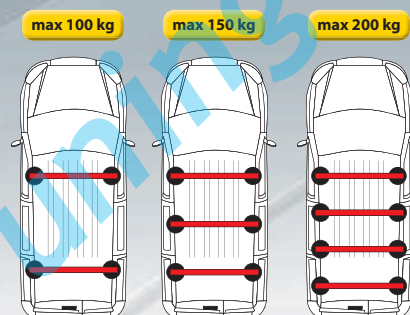

Marca e Modello Make and Model	Anno Year	Passo Wheelbase	Tetto Roof	Barra cm Bar cm	Kit 2 barre 2 bars kit	Kit 3 barre 3 bars kit	Kit 4 barre 4 bars kit
CITROEN							
Berlingo	7/96>3/08			135	N30012		
Berlingo	4/08>	Tutti - All		150	N30202	N30203	
Jumper	2/94>3/06	Corto - Short		180	N30022	N30023	
Jumper	2/94>3/06	Medio - Medium		180	N30022	N30023	
Jumper	2/94>3/06	Lungo - Long		180		N30023	
Jumper	4/06>	Corto - Short		180	N30032	N30033	N30032 x 2
Jumper	4/06>	Medio - Medium		180	N30032	N30033	N30032 x 2
Jumper	4/06>	Lungo - Long		180	N30032	N30033	N30032 x 2
Jumper	4/06>	Extra lungo - Extra long		180	N30032	N30033	N30032 x 2
Nemo	2/08>			135	N30182	N30183	
Jumpy	6/94>12/06			135		N30043	
Jumpy	1/07>			135	N30192	N30193	
DACIA							
Logan	2/07>			135	N30252	N30253	
FIAT							
Doblò	3/01>12/09			135	N30002	N30003	
Doblò	1/10>			150	N30272	N30273	
Ducato	3/94>6/06	Corto - Short	Basso - Low	180	N30022	N30023	
Ducato	3/94>6/06	Medio - Medium	Basso - Low	180	N30022	N30023	
Ducato	7/06>		Basso - Low	180	N30032	N30033	
Ducato	7/06>		Medio - Medium	180	N30032	N30033	N30032 x 2
Fiorino	1/88>1/08			135	N30052		
Fiorino	2/08>			135	N30182	N30183	
Qubo	2/08>			135	N30182	N30183	
Scudo	2/96>12/06			135		N30043	
Scudo	1/07>			150	N30192	N30193	
FORD							
Transit Connect	6/02>			135	N30082		
HYUNDAI							
H1	10/97>1/08	Corto - Short		150		N30063	
H1	10/97>1/08	Lungo - Long		150		N30073	
H1	2/08>	Tutti - All		150		N30233	



Marca e Modello Make and Model	Anno Year	Passo Wheelbase	Tetto Roof	Barra cm Bar cm	Kit 2 barre 2 bars kit	Kit 3 barre 3 bars kit	Kit 4 barre 4 bars kit
IVECO							
Daily	5/99>	Corto - Short	Basso - Low	180		N30093	
Daily	5/06>	Corto - Short	Medio - Medium	180		N30103	
Daily	5/06>	Medio - Medium	Medio - Medium	180		N30103	
Daily	5/06>	Lungo - Long	Medio - Medium	180		N30103	
MERCEDES							
Vito	3/97>8/03	Corto - Short	Basso - Low	150	N30112		
Vito	9/03>	Corto - Short	Basso - Low	150		N30113	
Vito	9/03>	Lungo - Long	Basso - Low	150		N30113	
Sprinter	6/06>	Tutti - All		180			N30214
NISSAN							
Interstar	7/02>	Corto - Short	Basso - Low	180		N30123	
Interstar	7/02>	Corto - Short	Medio - Medium	180		N30123	
Interstar	7/02>	Medio - Medium	Medio - Medium	180		N30123	
Interstar	7/02>	Medio - Medium	Alto - High	150		N30123	
Interstar	7/02>	Lungo - Long	Alto - High	150		N30123	
Kubistar	8/03>			135	N30132		
Primastar	9/02>			180		N30143	
Nv200	9/09>			135	N30262	N30263	
OPEL							
Combo	10/01>			135	N30242		
Movano	7/98>7/10	Corto - Short	Basso - Low	180		N30123	
Movano	7/98>7/10	Corto - Short	Alto - High	150		N30123	
Movano	7/98>7/10	Medio - Medium	Alto - High	150		N30123	
Movano	7/98>7/10	Lungo - Long	Alto - High	150		N30123	
Vivaro	8/01>			180		N30143	
PEUGEOT							
Boxer	3/94>3/06	Corto - Short		180	N30022	N30023	
Boxer	3/94>3/06	Medio - Medium		180	N30022	N30023	
Boxer	3/94>3/06	Lungo - Long		180	N30022	N30023	
Boxer	4/06>	Corto - Short		180	N30032	N30033	N30032 x 2
Boxer	4/06>	Medio - Medium		180	N30032	N30033	N30032 x 2
Boxer	4/06>	Lungo - Long		180	N30032	N30033	N30032 x 2
Boxer	4/06>	Extra lungo - Extra long		180	N30032	N30033	N30032 x 2
Expert	7/95>12/06	Corto - Short		135		N30043	
Expert	7/95>12/06	Lungo - Long		135		N30043	
Expert	1/07>			135	N30192	N30193	
Ranch	5/96>			135	N30012		
Partner	5/96>3/08			135	N30012		
Partner	4/08>			150	N30202	N30203	
Bipper	2/08>			135	N30182	N30183	
RENAULT							
Trafic	3/01>			180		N30143	
Master	7/98>	Corto - Short	Basso - Low	180		N30123	
Master	7/98>	Corto - Short	Medio - Medium	150		N30123	
Master	7/98>	Medio - Medium	Medio - Medium	150		N30123	
Master	7/98>	Medio - Medium	Alto - High	150		N30123	
Master	7/98>	Lungo - Long	Medio - Medium	150		N30123	
Master	7/98>	Lungo - Long	Alto - High	150		N30123	
Kangoo	8/97>1/08			135	N30132		
Kangoo	2/08>	Corto - Short		150	N30222		
Kangoo	2/08>	Lungo - Long		150	N30222		
VOLKSWAGEN							
Caddy	3/04>	Corto - Short	Basso - Low	135	N30162		
Caddy Maxi	9/07>	Lungo - Long	Basso - Low	135		N30163	
Crafter	4/06>			180			N30214
Transporter T5	4/03>	Corto - Short	Basso - Low	150	N30172		N30172 x 2