

2 x 

4 x 
OK CARVING



Alluminio  



NORDIC-KING ALUMINIUM NK-40
Coppia portasci universali per 4 paia di sci oppure 2 snow boards. Con chiave antifurto.

NORDIC-KING ALUMINIUM NK-40
Universal anti-theft ski-carriers for 4 ski pairs / 2 snow boards

20074 (fino ad esaurimento)
N40010 (nuovo codice)

Scatola / Box  4



 **IN DOTAZIONE:**

- Staffe per barre portatutto in acciaio (Max 60x60 mm)
- Raccordi per barre portatutto in alluminio con profilo a "T"

INCLUDED:

- Fitting brackets for steel bars (mm 60x60 max)
- "T" adapters for ready-made aluminium bars





4 x 

6 x 
OK CARVING

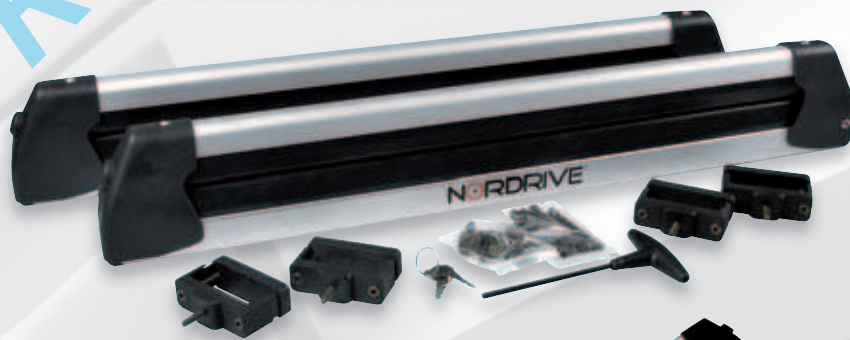

Alluminio  



NORDIC-KING ALUMINIUM NK-60
Coppia portasci universali per 6 paia di sci oppure 4 snow boards. Con chiave antifurto.

NORDIC-KING ALUMINIUM NK-60
Universal anti-theft ski-carriers for 6 ski pairs / 4 snow boards

20075 (fino ad esaurimento)
N40011 (nuovo codice)

Scatola / Box  4



 **IN DOTAZIONE:**

- Staffe per barre portatutto in acciaio (Max 60x60 mm)
- Raccordi per barre portatutto in alluminio con profilo a "T"

INCLUDED:

- Fitting brackets for steel bars (mm 60x60 max)
- "T" adapters for ready-made aluminium bars





Portasci tradizionali | Classic ski carriers

4 x 

6 x 
OK CARVING

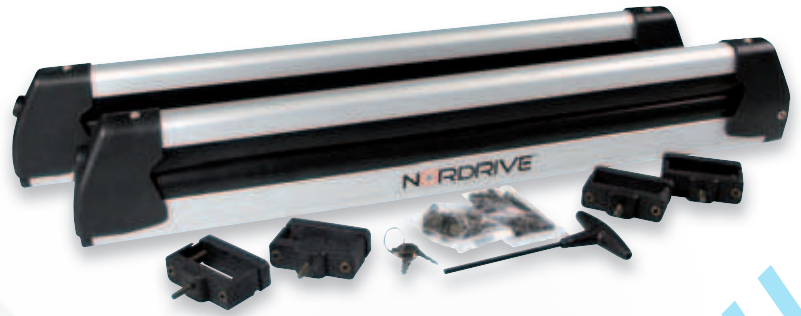

Alluminio  



PRO-SLIDER ALUMINIUM PS-60

Coppia portasci universali per 6 paia di sci oppure 4 snow boards. Con chiave antifurto. Il sistema di scorrimento consente di caricare e scaricare gli sci senza fatica.

PRO-SLIDER ALUMINIUM PS-60

Universal anti-theft ski-carriers for 6 ski pairs / 4 snow boards. With Pro-Slider, the ski-carrier slides out from the roof for a most convenient loading and unloading of the ski. No more stepping onto the door step/line and leaning onto the car roof. Easy to use and mount

20076	(fino ad esaurimento)
N40000	(nuovo codice)

Scatola / Box  4



 **IN DOTAZIONE:**

- Staffe per barre portatutto in acciaio (Max 60x60 mm)
- Raccordi per barre portatutto in alluminio con profilo a "T"

INCLUDED:

- Fitting brackets for steel bars (mm 60x60 max)
- "T" adapters for ready-made aluminium bars



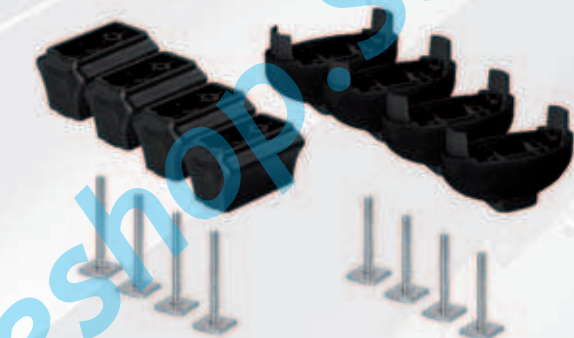

EXTENSION, KIT DISTANZIALI PER PORTASCI

Per aumentare la distanza del portasci dal tetto del veicolo ed evitare che gli sci danneggino la carrozzeria.

Indispensabile quando le barre porta tutto sono a profilo basso (poco distanti dal tetto); oppure quando gli sci vengono trasportati in modo sovrapposto e gli attacchi sono rivolti anche verso il basso.

Universali per barre standard o con raccordo a T

EXTENSION, SKI CARRIER SPACERS KIT

To increase the gap between roof and skicarrier and avoid bindings damaging car roof. Essential when the roof bars have a low profile and the gap between roof and bars is limited; or when carving skies are transported with the binding facing down.

Universal fit for standard or T-track bars

N40050

Scatola / Box  100

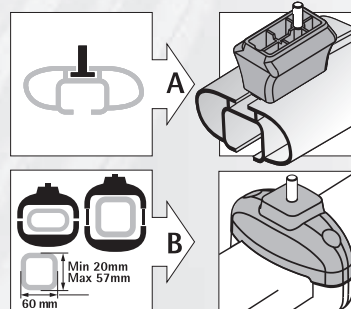
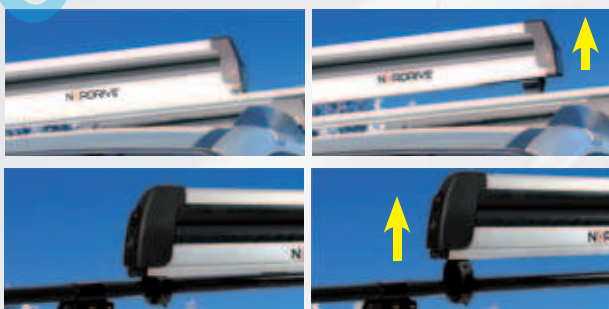

Extension

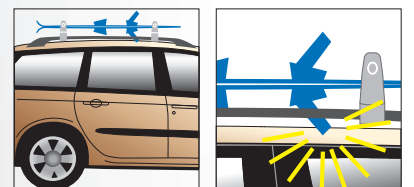

Portasci tradizionali | Classic ski carriers



2 x 

4 x 

OK CARVING







Alluminio



SNOW-TECH X-4/2 ALUMINIUM
Portasci universale per 4 paia di sci oppure 2 snow boards. Con chiave antifurto.

SNOW-TECH X-4/2 ALUMINIUM
Universal antitheft ski carrier for 4 ski pairs / 2 snow boards

20001

Cavaliere / Header 4





4 x 

6 x 

OK CARVING





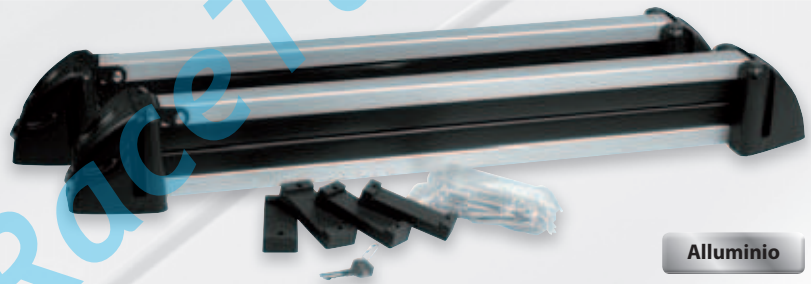

Alluminio



SNOW-TECH X-6/4 ALUMINIUM
Portasci universale per 6 paia di sci oppure 4 snow boards. Con chiave antifurto

SNOW-TECH X-6/4 ALUMINIUM
Universal antitheft ski carrier for 6 ski pairs / 4 snow boards

20009

Cavaliere / Header 4



Portasci magnetici | Magnetic ski carriers



2 x 
OK CARVING



SKI-TECH MAGNETIC X2
Portasci magnetico per 2 paia di sci.
Universale.
Si monta senza alcun attrezzo

SKI-TECH MAGNETIC X2
Magnetic ski-carrier for 2 ski pairs.
Universal fit

20015

Scatola / Box  4



2 x 
OK CARVING



CARVER
Portasci magnetico per 2 paia di sci
normali o carving. Universale, con chiave
antifurto. Si monta senza alcun attrezzo

CARVER
Magnetic ski carrier for 2 pairs of skis
and sticks. With key lock, Gs-Tuv approved,
hold normal and carver skis

20017

Scatola / Box  5



2 x 
3 x 
OK CARVING



MYURA S
Portasci magnetico per tre paia di
sci normali o carving, oppure per 2
snowboard. Chiusura antifurto con chiave.
Universale

MYURA S
Magnetic ski-carrier for 3 ski pairs regular
or carving, or for 2 snowboards. Antitheft
look with key. Universal

N40100

Scatola / Box  2



D-BOX 330

D-BOX, BOX TETTO IN ABS 330 L

ABS con metacrilato acrilico antigraffio. Ottima protezione UV e brillantezza superficiale. Spessore di partenza 4mm. Protezione in PE removibile (ad eccezione della versione con coperchio in ABS grigio goffrato).

Chiusura:

Centralizzata a 2 punti di ancoraggio.

Sistema di apertura:

Compassi metallici con carenatura della molla.

Sistema di aggancio alle barre:

Pomelli, piastrine con doppia foratura, passa cinghia. Doppio set di 4+4 cavallotti (L 65 mm+L 105 mm).

Dotazione:

Completa di 2 pratiche cinghie per il bloccaggio interno del carico e libretto di istruzioni / manutenzione.

D-BOX, ABS ROOF BOXES 330 L

ABS with anti-scratch acrylic methacrylate. Impact-proof. UV-resistant ABS plastic. 4mm thickness at origin. Removable PE protection film (Except the embossed grey version)

Lock:

Central locking system with 2 fastening points.

Opening system:

Calliper with contrast spring.

Fitting system to the bars:

4+4 "U" hooks (W 65 mm + W 105 mm) and fitting accessories.

Included:

Instructions manual + 2 fixing straps for the easy locking of the cargo

N60000	Grigio goffrato Embossed Grey
N60001	Argento lucido Shiny Silver
N60002	Nero lucido Shiny Black
N60003	Bianco lucido Shiny White

Cartone 1

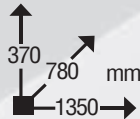
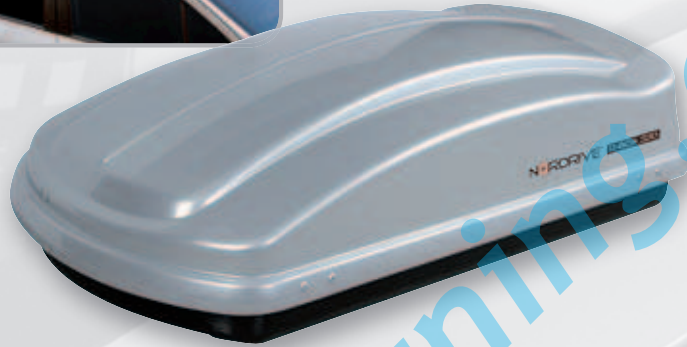
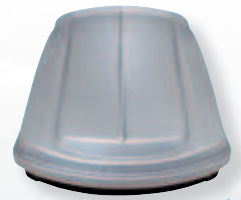

COLORI DISPONIBILI - AVAILABLE COLOURS

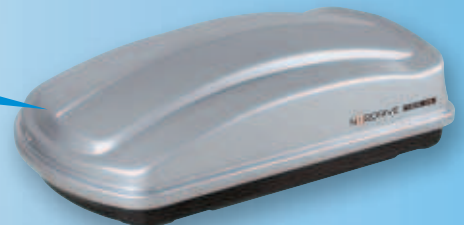
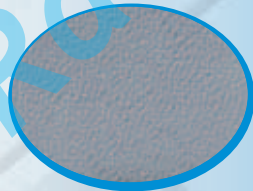

GRIGIO goffrato
GREY embossed

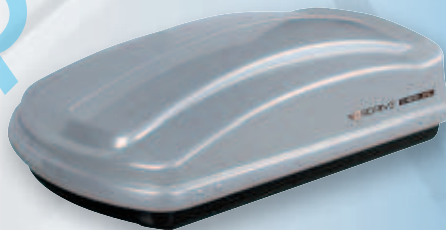

ARGENTO metallizzato - lucido
SILVER metallic - shiny



NERO lucido
BLACK shiny

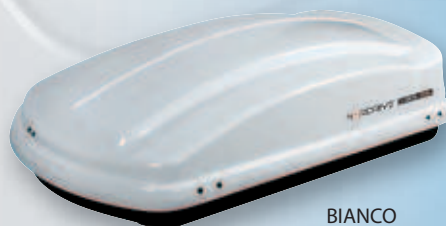

BIANCO lucido
WHITE shiny

In dotazione doppio kit di fissaggio per barre da:

Included double fixing kit for bars:

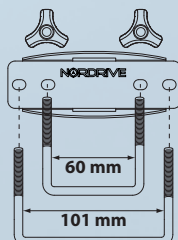
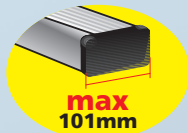

D-BOX 430

D-BOX, BOX TETTO IN ABS 430 L
 ABS con metacrilato acrilico antigraffio. Ottima protezione UV e brillantezza superficiale. Spessore di partenza 4 mm. Protezione in PE removibile (ad eccezione della versione con coperchio in ABS grigio goffrato).

Chiusura:
 Centralizzata a 3 punti di ancoraggio.

Sistema di apertura:
 Compassi metallici con carenatura della molla.

Sistema di aggancio alle barre:
 Pomelli, piastrine con doppia foratura, passa cinghia. Doppio set di 4+4 cavallotti (L 65 mm+L 105 mm).

Dotazione:
 Completa di 2 pratiche cinghie per il bloccaggio interno del carico e libretto di istruzioni / manutenzione.

D-BOX, ABS ROOF BOXES 430 L
 ABS with anti-scratch acrylic methacrylate. Impact-proof. UV-resistant ABS plastic. 4mm thickness at origin. Removable PE protection film (Except the embossed grey version)

Lock:
 Central locking system with 3 fastening points.

Opening system:
 Calliper with contrast spring.

Fitting system to the bars:
 4+4 "U" hooks (W 65 mm + W 105 mm) and fitting accessories.

Included:
 Instructions manual + 2 fixing straps for the easy locking of the cargo.

N60010	Grigio goffrato Embossed Grey
N60011	Argento lucido Shiny Silver
N60012	Nero lucido Shiny Black
N60013	Bianco lucido Shiny White

Cartone 1

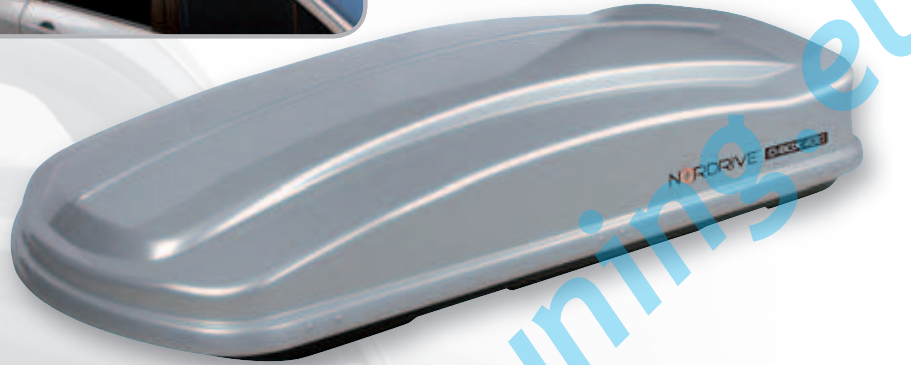
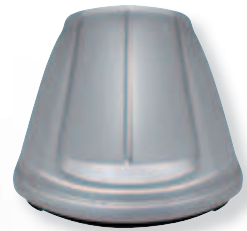

COLORI DISPONIBILI - AVAILABLE COLOURS



GRIGIO
goffrato
GREY
embossed



ARGENTO
metallizzato - lucido
SILVER
metallic - shiny



NERO
lucido
BLACK
shiny



BIANCO
lucido
WHITE
shiny

In dotazione doppio kit di fissaggio per barre da:

Included double fixing kit for bars:

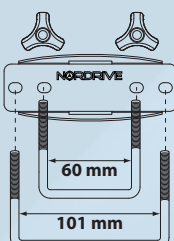
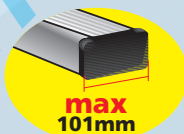

D-BOX 530

D-BOX, BOX TETTO IN ABS 530 L

ABS con metacrilato acrilico antigraffio. Ottima protezione UV e brillantezza superficiale. Spessore di partenza 4 mm. Protezione in PE removibile (ad eccezione della versione con coperchio in ABS grigio gofrato).

Chiusura:

Centralizzata a 3 punti di ancoraggio.

Sistema di apertura:

Compassi metallici con carenatura della molla.

Sistema di aggancio alle barre:

Pomelli, piastrine con doppia foratura, passa cinghia. Doppio set di 4+4 cavallotti (L 65 mm+L 105 mm).

Dotazione:

Completa di 2 pratiche cinghie per il bloccaggio interno del carico e libretto di istruzioni / manutenzione.

D-BOX, ABS ROOF BOXES 530 L

ABS with anti-scratch acrylic methacrylate. Impact-proof. UV-resistant ABS plastic. 4 mm thickness at origin. Removable PE protection film (Except the embossed grey version)

Lock:

Central locking system with 3 fastening points.

Opening system:

Calliper with contrast spring.

Fitting system to the bars:

4+4 "U" hooks (W 65 mm + W 105 mm) and fitting accessories.

Included:

Instructions manual + 2 fixing straps for the easy locking of the cargo

N60020	Grigio gofrato Embossed Grey
N60021	Argento lucido Shiny Silver
N60022	Nero lucido Shiny Black
N60023	Bianco lucido Shiny White

Cartone 1

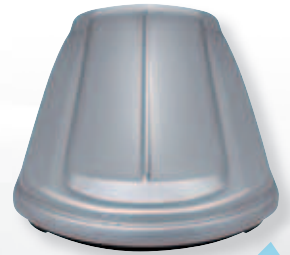

COLORI DISPONIBILI - AVAILABLE COLOURS



GRIGIO
gofrato
GREY
embossed



ARGENTO
metallizzato - lucido
SILVER
metallic - shiny



NERO
lucido
BLACK
shiny



BIANCO
lucido
WHITE
shiny

In dotazione doppio kit di fissaggio per barre da:

Included double fixing kit for bars:

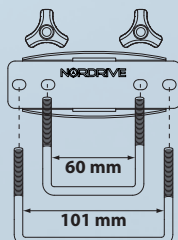
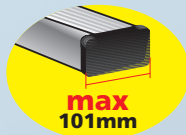

Modello Model	D-BOX 330				D-BOX 430				D-BOX 530			
	N60000	N60001	N60002	N60003	N60010	N60011	N60012	N60013	N60020	N60021	N60022	N60023
Colore coperchio Colour of the top	Grigio goffrato Embos. grey	Argento lucido Shiny silver	Nero lucido Shiny black	Bianco lucido Shiny white	Grigio goffrato Embos. grey	Argento lucido Shiny silver	Nero lucido Shiny black	Bianco lucido Shiny white	Grigio goffrato Embos. grey	Argento lucido Shiny silver	Nero lucido Shiny black	Bianco lucido Shiny white
Colore fondo Colour of the bottom	Nero Black				Nero Black				Nero Black			
Lunghezza (interno) Length (inside)	cm 135 (125)				cm 190 (180)				cm 203 (190)			
Larghezza (interno) Width (inside)	cm 78 (70)				cm 78 (70)				cm 90 (80)			
Altezza (interno) Height (inside)	cm 37 (33)				cm 36 (32)				cm 40 (36)			
Capacità Capacity	lt 330				lt 430				lt 530			
Peso Weight	kg 11				kg 14				kg 17			
Carico massimo Max load	kg 75				kg 75				kg 75			
Materiale Material	ABS+PMMA				ABS+PMMA				ABS+PMMA			
Apertura Opening	Laterale destra Right side				Laterale destra Right side				Laterale destra Right side			
Sollevatore a molla Lifting spring	Compasso metallico Caliper with contrast spring				Compasso metallico Caliper with contrast spring				Compasso metallico Caliper with contrast spring			
Chiusura centralizzata (punti) Central locking system (points)	2				3				3			
Cinghia ancoraggio bagagli Luggage fastening straps	2				2				2			
Protezione in PE removibile Removable PE protection film	-	●	●	●	-	●	●	●	-	●	●	●
Indicato per sci carving Suitable for carving skis	-				●				●			
Indicato per snowboards Suitable for snowboards	-				●				●			
Indicato per sci da fondo Suitable for cross-country skis	-				-				●			
Garanzia anni Guarantee years	3				3				3			
Omologazione TÜV TÜV approved	●				●				●			
Attacchi barre portatutto Roof bars fixing	4x60 mm + 4x101 mm				4x60 mm + 4x101 mm				4x60 mm + 4x101 mm			

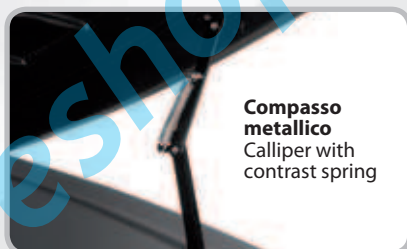

Compasso metallico
Calliper with contrast spring

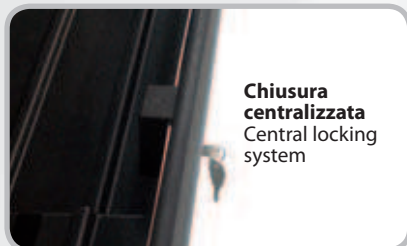

Chiusura centralizzata
Central locking system



Cinghie ancoraggio bagagli
Straps



ESPOSITORE PER 3 D-BOX
Con ripiano centrale estraibile
DISPLAY RACK FOR 3 D-BOX
With sliding central shelf

N60030

Scatola / Box 1