

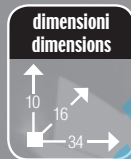

48



5L

SPEED TOUR

90267

SPEED TOUR, BORSA SERBATOIO MAGNETICA

In poliestere con inserti alta visibilità, capacità 5 lt, 3 vani. Cappuccio anti-pioggia in nylon. Tracolla per il trasporto a spalla.

SPEED TOUR, CORDURA MAGNETIC BAG

Polyester material, reflective inserts. 5 ltrs capacity, 3 practical pockets. Rain cover included, shoulder-bag belt.

Busta / Bag 20

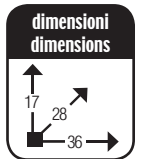

21L

T.MAXTER TANK

90268

T-MAXTER TANK, BORSA SERBATOIO MAGNETICA

In poliestere con inserti alta visibilità, capacità 21 lt, 4 vani. Cappuccio anti-pioggia in nylon. Tracolla per il trasporto a spalla.

T-MAXTER TANK, CORDURA MAGNETIC TANK BAG

Polyester material, reflective inserts. 21 ltrs capacity, 4 practical pockets. Rain cover included, shoulder-bag belt.

Busta / Bag 10

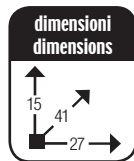

28L

T-MAXTER REAR

90270

T-MAXTER REAR, BAULE SOFT POSTERIORE

In poliestere con inserti alta visibilità, capacità 28 lt. Tasche multiple con cerniere. Cappuccio anti-pioggia nylon.

T-MAXTER REAR, CORDURA TAIL BAG

Polyester material, reflective inserts. 28 ltrs capacity, 4 practical pockets. Rain cover included.

Busta / Bag 10

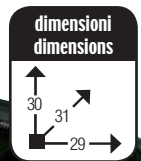

2 PCS

24Lx2

T-MAXTER SIDE

90269

T-MAXTER SIDE, COPPIA BORSE LATERALI UNIVERSALI

In poliestere con inserti alta visibilità. Capacità variabile da 16 lt a 24 lt cadauna. Tasche multiple con cerniere, cappuccio anti-pioggia in nylon, tracolla per il trasporto a spalla.

T-MAXTER SIDE, CORDURA PANNIER BAGS (2 pcs)

Polyester material, reflective inserts. Capacity from 16 up to 24 ltrs. Multi pockets. Rain cover included. Shoulder-bag belt.

Busta / Bag 10

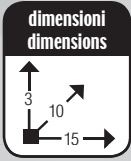

90265

MULTI-HOLDER, ASTUCCIO IMPERMEABILE PORTA PDA PER MOTO

Per navigatori gps, telefoni, palmari, I-pod, ecc... Fissaggio tramite velcro bi-adesivo o supporti manubrio da Ø22 a 30 mm. Foro passacavo con membrana anti-acqua.

MULTI-HOLDER, WATERPROOF PDA HOLDER FOR MOTORCYCLES

For mobile phones, gps, pocket pc, I-pod etc. Double sided adhesive velcro tape and metal fitting brackets suitable for round handlebars from 22 to 30 mm Ø. Waterproof hole for the passage of cable.

Scatola / Box ☐ 10 / 100

50

Attacco universale
Universal fit



90264

GULLIVER, PORTA OGGETTI IMPERMEABILE PER MOTO

Multiuso: Telefoni, I-pod, telepass, carte di credito ecc...

Tripla possibilità di fissaggio:

- Velcro con bi-adesivo
- Tramite speciali strisce a velcro
- Passante per cintura.

GULLIVER, WATERPROOF MOTORCYCLE CASE

Suitable for: mobile telephone, I-pod, telepass, credit card, etc...

Triple fixing system:

- Velcro-strap with double-sided tape.
- Special velcro stripes.
- Belt loop.

Scatola / Box ☐ 5 / 25

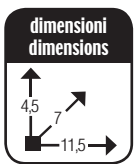

90266

TANK-BAG, BORSA SERBATOIO COMPATTA

Dotata di numerose tasche facilmente accessibili tramite chiusure a strappo o cerniere.

In dotazione: cinghie di fissaggio, tracolla, maniglia da trasporto e copertura impermeabile.

COMPACT TANK-BAG

Bag equipped with multiple pockets for Map, Documents, Coins, Cards, Pens, Keys. Supplied with fitting strap, carry handle, shoulder strap, elastic cords, waterproof rain cover.

D/Blister ☐ 20

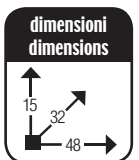



- 60182** cm 2x60
- 60192** cm 2x80
- 60202** cm 2x100
- 60212** cm 2x150
- 60222** cm 2x200



CORDE ELASTICHE Ø 10 mm

In lattice di gomma multifilare con rivestimento in nylon. Ganci in acciaio temperato con plastificazione superficiale e tappi antigraffio. Omologate TÜV-SÜD. Confezione da 2 pezzi

ELASTIC CORDS Ø 10 mm

Multifilament latex straps with nylon PP webbing. Hardened metal hooks with epoxy coating and anti-scratch caps. TÜV-SÜD approved. Pair pack.

Busta / Bag 10 / 60



- 90500** Nero / Black
- 90501** Rosso / Red
- 90502** Blu / Blue



RETE ELASTICIZZATA SPIDER

Rete elastica Ø 4 mm con rivestimento PP antistrappo. 6 ganci regolabili con diametro 4 mm, dimensioni cm 42x42.

SPIDER, MULTIPURPOSE ELASTIC NET

Ø 4 mm elastic net with anti-pull PP covering. Six adjustable hooks (Ø 4 mm), dimensions 42x42 cm.

D/Blister 12 / 24



60159

NASTRO TENSORE cm 500+20

Con fibbia di bloccaggio rapido e 2 ganci ad "S" in acciaio plastificato. Larghezza nastro cm 2,5.

500+20 cm RATCHET TIE DOWN STRAP

With 2 "S" hooks, strap width cm 2,5.

D/Blister 12 / 24

60150

SET 2 NASTRI TENSORI cm 250

SET 2 x 250 cm RATCHET TIE DOWN STRAPS

D/Blister 12 / 24



60162

NASTRO TENSORE cm 450+50

Con cricchetto in acciaio e 2 ganci ad "S" in acciaio plastificato. Larghezza nastro cm 2,5.

450+50 CM RATCHET TIE DOWN STRAP

With two "S" plastic coated hooks, strap width cm 2,5.

D/Blister 12 / 24

60166	2,5 x 500 cm	125 daN
--------------	--------------	---------

PRO-SAFE, SET 2 NASTRI TENSORI CON CRICCHETTO A DOPPIO GANCIO "S"

Cricchetto con impugnature gommate. Ganci plastificati. Nastro in PP per fissare, legare o ancorare gli oggetti trasportati.

PRO-SAFE, HEAVY DUTY RATCHET TIE-DOWN STRAPS SET

Rubber grip Ratchet. Plastic coated hooks. PP strap to secure fastening of transported cargo.

Cavaliere / Header 12

2 PCS



60167	3,5 x 500 cm	400 daN
--------------	--------------	---------

PRO-SAFE, SET 2 NASTRI TENSORI CON CRICCHETTO A DOPPIO GANCIO

Cricchetto con impugnature gommate. Ganci plastificati. Nastro in PP per fissare, legare o ancorare gli oggetti trasportati.

PRO-SAFE, HEAVY DUTY RATCHET TIE-DOWN STRAPS SET

Rubber grip Ratchet. Plastic coated hooks PP strap to secure fastening of transported cargo.

Cavaliere / Header 6

2 PCS



FOCUS

90281

FOCUS, BAULETTO MOTO 29 LITRI

Colore nero gofrato.
Completo di piastra e viti per il fissaggio.
Sistema di gancio-sgancio rapido.
2 chiavi in dotazione.
Lunghezza 38 cm, altezza 31 cm, profondità 40 cm.

FOCUS, 29 LT MOTORCYCLE TAIL BOX

Black embossed colour.
Fixing kit included.
Supplied with 2 keys.
Quick connector-release system.
38 cm Length, 31 cm height, 40 cm depth.

Scatola / Box 1

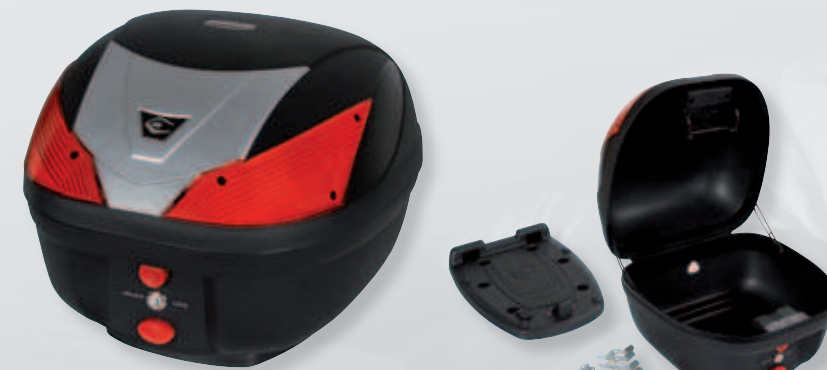

litri / litres	max load kg	capacità/capacity	dimensioni dimensions
29	4,5	 Integrale / Full face	

WIZARD

90282

WIZARD, BAULETTO MOTO 36 LITRI



Colore nero gofrato.
Completo di piastra e viti per il fissaggio.
Sistema di gancio-sgancio rapido.
2 chiavi in dotazione.
Lunghezza 45 cm, altezza 31 cm, profondità 41,2 cm.

WIZARD, 36 LT MOTORCYCLE TAIL BOX

Black embossed colour.
Fixing kit included.
Supplied with 2 keys.
Quick connector-release system.
45 cm Length, 31 cm height, 41,2 cm depth.

Scatola / Box 1

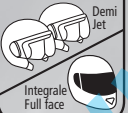

litri / litres	max load kg	capacità/capacity	dimensioni dimensions
36	4,5	 Demi Jet Integrale Full Face	

REFLEX

90283

REFLEX, BAULETTO MOTO 50 LITRI



Colore nero gofrato.
Completo di piastra e viti per il fissaggio.
Sistema di gancio-sgancio rapido.
2 chiavi in dotazione.
Lunghezza 57,6 cm, altezza 31 cm, profondità 44 cm.

REFLEX, 50 LT MOTORCYCLE TAIL BOX

Black embossed colour.
Fixing kit included.
Supplied with 2 keys.
Quick connector-release system.
57,6 cm Length, 31 cm height, 44 cm depth.

Scatola / Box 1



litri / litres	max load kg	capacità/capacity	dimensioni dimensions
50	4,5	 Integrale / Full face	



90290

ADATTATORE UNIVERSALE PER BAULETTI COOCASE

Consente di fissare i bauletti della linea Coocase sulle staffe di Givi, Kappa, Shad, Sw-Motech, Krauser e Five Stars.

UNIVERSAL ADAPTOR FOR COOCASE TAIL BOXES

To install Coocase tail boxes on the racks of Givi, Kappa, Shad, Sw-Motech, Krauser and Five Stars.

Busta / Bag 30

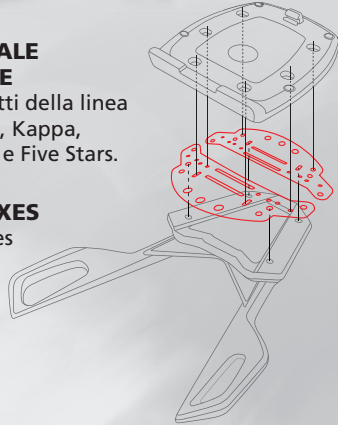

90288

SCHIENALINO, PER BAULETTI COOCASE 36/50 LITRI

BACKREST, FOR COOCASE TAIL BOXES 36/50 LITRES

Busta / Bag 1 / 20



90396	PIAGGIO Fly 50-125	2004>2009	Scatola / Box 1
90397	PIAGGIO Beverly + Vespa 400	2004>2007	Scatola / Box 1
90398	PIAGGIO Vespa LX 50-125-150	2005>2008	Scatola / Box 1
90399	HONDA Transalp	2008	Scatola / Box 1
90401	YAMAHA T-Max 500	2008	Scatola / Box 1
90402	YAMAHA T-Max 500	2001>2007	Scatola / Box 1
90404	YAMAHA Majesty 400	2004>2007	Scatola / Box 1
90408	SUZUKI V-Strom 650-1000	2002>2009	Scatola / Box 5
90411	SUZUKI Burgman 400 K7	2006	Scatola / Box 1

STAFFA PORTAPACCHI

Consente di fissare i bauletti della linea Coocase al telaio della moto o scooter.

TAIL BOX FITTING BRACKET

Enables to install the Coocase tail boxes onto motorbikes and scooters.

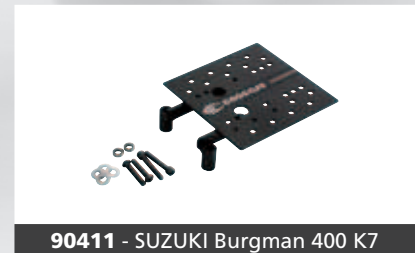
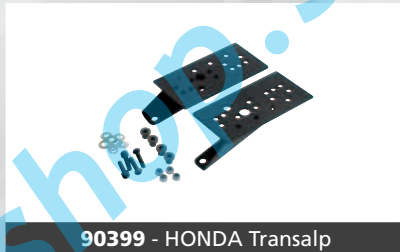

Numerosi modelli sono in approntamento. Per la distinta aggiornata dei modelli attualmente disponibili, consultare il sito Lampa
Several new models are being developed. For an updated list of currently available models, refer to Lampa website

www.lampa.it

