



2 PCS

- **70263** Blu - Blue
- **70264** Rosso - Red
- **70266** Verde - Green

DECOR-LED 12V

Coppia diodi luminosi ad alta luminescenza incassati in viti metalliche pronte per il montaggio. Impermeabili.

DECOR-LED 12V

Led screw lights. Waterproof.

D/Blister 10 / 100



4 PCS

- **70424** Ø 5 mm Blu - Blue
- **70425** Ø 5 mm Rosso - Red
- **70426** Ø 5 mm Verde - Green
- **70427** Ø 5 mm Bianco - White
- **70428** Ø 5 mm Viola - Purple
- **70429** Ø 5 mm 7 colori / colours

SET 4 LED 12V

Alta luminescenza, lunga durata (oltre 10.000 ore). Montaggio ad incasso.

SET OF 4 LED DOTS 12V

Mount anywhere, easy to install, 10.000 hours life span.

D/Blister 10 / 100

- **70451** Ø 3 mm Blu - Blue
- **70452** Ø 3 mm Rosso - Red
- **70453** Ø 3 mm Verde - Green
- **70454** Ø 3 mm Bianco - White
- **70455** Ø 3 mm Viola - Purple



2 PCS

- **70331** Blu - Blue
- **70332** Rosso - Red
- **70333** Bianco - White

TWIN-LED 12V

Micro lampade cromate e carenate con proiettore a doppio led. Base adesiva 3M®, impermeabili, cavo da 5 metri.

TWIN-LED 12V

Adhesive fender lamp. Chromed housing, 2 coloured led. 3M® adhesive. 5 m connection cable.

D/Blister 10 / 100



2 PCS

- **70212** Bianco - White
- **70213** Rosso - Red
- **70217** Blu - Blue
- **70218** Verde - Green

MICRO-LITES, COPPIA MICROLUCI ADESIVE 12V

Misura piccola

12V MULTIPURPOSE ADHESIVE MICRO-LIGHTS (pair)

Small size

D/Blister 12 / 360



2 PCS

70220

MICROLUCI ADESIVE 12V

Multiuso, Dimensioni 57x37x9 mm

ADHESIVE MULTIFUNCTION MINI LAMPS

Size 57x37x9 mm

Blister 25 / 150





- **45580** Rosso - Red
- **45581** Verde - Green
- **45582** Blu - Blue

SPIA A LED

Foro Ø 11,2 mm.
Spessore max da 0,5 a 5 mm

LED INDICATOR LIGHT

Hole Ø 11,2 mm. From 0,5 to 5 mm max depth

Blister 10 / 100

2 PCS



- **70430** Blu - Blue
- **70431** Rosso - Red
- **70433** Bianco - White

STROBO-LED 12V

Coppia barre stroboscopiche.

STROBO-LED 12V

Universal Led strobes.

D/Blister 10 / 100



Ø 35 mm

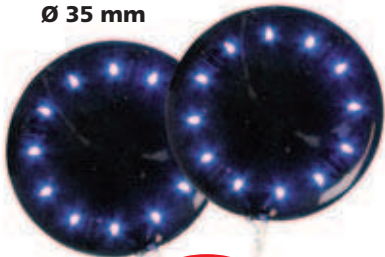

2 PCS

- **73475** Blu - Blue
- **73476** Bianco - White
- **73479** Rosso - Red

LED-DISKS 12V

Coppia dischi luminosi a 12 Led.

Ultrasottili, flessibili,
con retro adesivo 3M®.

LED-DISKS 12V

Water resistant. Low profile design.
Flexible may be curved.

3M® adhesive base.

D/Blister 10 / 100



2 PCS



- **73480** 20 cm - 10 Led Blu - Blue
- **73481** 20 cm - 10 Led Verde - Green
- **73482** 20 cm - 10 Led Viola - Purple
- **73483** 20 cm - 10 Led Rosso - Red
- **73484** 20 cm - 10 Led Bianco - White
- **73485** 40 cm - 15 Led Blu - Blue
- **73486** 40 cm - 15 Led Verde - Green
- **73488** 40 cm - 15 Led Rosso - Red
- **73489** 40 cm - 15 Led Bianco - White

TWIN LED-BAR 12V

Barre luminose a led multipli.

Ultrasottili leggermente flessibili, con retro adesivo 3M®. Impermeabili

TWIN LED-BAR 12V

Rainproof.

Flexible may be slightly curved to follow fitting surface.

3M® adhesive base for an easy installation.

D/Blister 10 / 40

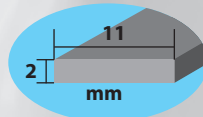

1 PCS



- **73575** 20 cm - 10 Led Blu - Blue
- **73578** 20 cm - 10 Led Ambra - Amber
- **73579** 20 cm - 10 Led Rosso - Red
- **73580** 30 cm - 15 Led Blu - Blue
- **73582** 30 cm - 15 Led Verde - Green
- **73583** 30 cm - 15 Led Ambra - Amber
- **73584** 30 cm - 15 Led Rosso - Red

LED-FLEX STRIP 12V

Striscia a diodi luminosi multipli, impermeabile. Ultrasottile in morbido PVC, flessibile, con retro adesivo 3M®. Basso assorbimento di corrente.

LED-FLEX STRIP 12V

Rainproof.

Low profile design mounts virtually anywhere.

Flexible may be curved to follow fitting surface.

3M® adhesive base for an easy installation.

D/Blister 10 / 50

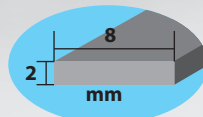

12V



11 LED

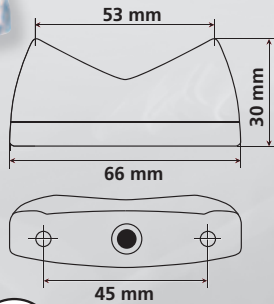

3 FUNZIONI FUNCTIONS



LUCE STOP
STOP LIGHT
ROSSO/RED



LUCE POSIZIONE
REAR LIGHT
ROSSO/RED



LUCE TARGA
LICENCE PLATE LIGHT
BIANCO/WHITE

E8 50R

Omologazione Europea
ECE Approval



90158

CONCEPT, FANALE POSTERIORE A LED

Facile montaggio tramite viti in dotazione.
Led di lunghissima durata, basso consumo ed alta luminescenza.
Impermeabile.
Universale.

CONCEPT, LED TAIL LIGHT

Easy to fit.
Long life, low consumption, high brightness LED.
Waterproof.
Universal.

D/Blister 5 / 50

12V

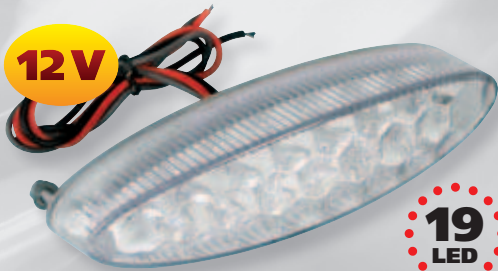

19 LED



2 FUNZIONI FUNCTIONS



LUCE STOP
STOP LIGHT
ROSSO/RED



LUCE POSIZIONE
REAR LIGHT
ROSSO/RED

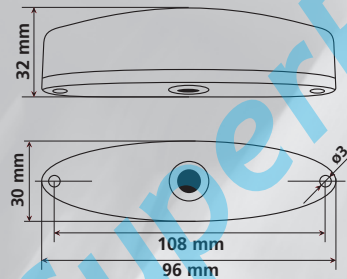

E8 50R

Omologazione Europea
ECE Approval

90159

PORSTER, FANALE POSTERIORE A LED

Facile montaggio tramite viti in dotazione.
Led di lunghissima durata, basso consumo ed alta luminescenza
Impermeabile.
Per moto, ciclomotori e scooter.

PORSTER, LED TAIL LIGHT

Easy to fit.
Long life, low consumption, high brightness LED.
Waterproof.
Fits motorcycles, mopeds and scooter.

D/Blister 5 / 50



12V



Luce Bianca / White Light 6000MCD

90170	Alluminio / Aluminium
90171	Blu / Blue
90172	Oro / Gold
90173	Rosso / Red
90174	Nero / Black

Luce Blu / Blue Light 2000MCD

90175	Alluminio / Aluminium
90176	Blu / Blue
90177	Oro / Gold
90178	Rosso / Red
90179	Nero / Black

SET 2 VITI CON LED

In alluminio anodizzato.
Aumentano la visibilità notturna della moto.
Idonee per targhe, blocchi motore, puntali etc...
Resistenti all'acqua e alle vibrazioni.

LED SCREWS (2pcs)

Anodized aluminium.
Increase the night visibility of motorcycles.
Suitable for number plate, engine, spoilers...
Water and vibration proof.

D/Blister 10 / 100

M8x20mm

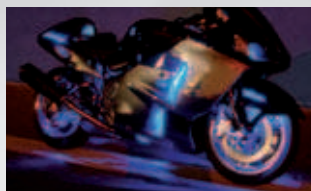
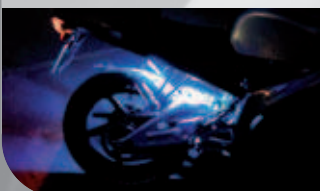

FLEX-STRIP

21 LED

50 cm

12V

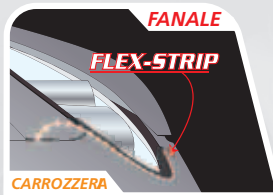

Esempio di installazione
Fitting example



Tra fanale
e carene
Between lights
and motorcycle body

2 PCS

- **73628** 2x50 cm - 21 Led Bianco - White
- **73629** 2x50 cm - 21 Led Rosso - Red

FLEX STRIP, STRISCE A LED MULTIPLI
Impermeabili, per uso esterno. Ultrasottili, si inseriscono virtualmente in qualsiasi fessura.

Flessibili, possono essere accorciate tagliando lungo le linee tracciate. Basso assorbimento di corrente.

Il rivestimento ed il circuito stampato possono essere tagliati ed accorciati di multipli di 3 Led (72mm).

FLEX STRIP, LED DAY-TIME RUNNING LIGHTS
Rainproof - for exterior use.

Extreme low-profile design, mounts virtually anywhere.

Flexible, may be curved to follow light shape.

This plastic strip and the circuit board may be shortened and cut along the white cutting line, printed on the circuit board. The cutting is possible every 3 Led / 72mm.

D / Blister 5 / 50

2 PCS



12V - H3 - 55W

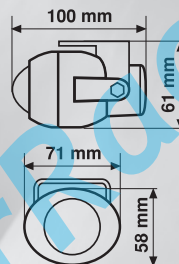

72182 MICRO-PROJECTOR 2 FENDINEBBIA BIANCO 12V
Fari alogeni lenticolari. Kit completo per il montaggio.

MICRO-PROJECTOR 2, FOG WHITE LENS 12V
New series of projector beam halogen fog lamps. DIY kit

D/Blister 3 / 12

E13 ECE approved

2 PCS



12V - H3 - 55W

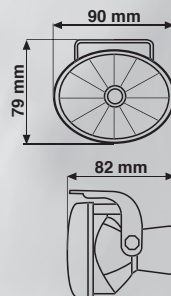

72350 LUMINUX 12V
Fari alogeni di profondità. Parabola con tecnologia multisuperficie.

LUMINUX 12V
Halogen driving lights. Advanced technology multi-surface reflector.

Scatola / Box 12

E11 ECE approved

2 PCS



12V - H3 - 55W



72357 HYENA 12V
Fari alogeni di profondità. Parabola con tecnologia multisuperficie

HYENA 12V
Halogen driving lights. Advanced technology multi-surface reflector

Scatola / Box 12

E11 ECE approved

2 PCS



12V - H3 - 55W

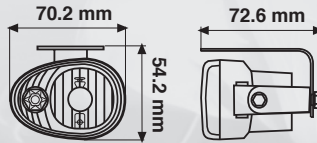

LED

BILUCE
POSIZIONE A LED+H3
2 LIGHTS
LED POSITION+H3

72356

FOX 12V

Fari alogeni antinebbia, con luce di posizione a Led. Parabola con tecnologia multisuperficie.

FOX 12V

Halogen fog lights with Led position light. Advanced technology multi-surface reflector.

Scatola / Box 12

E4 ECE approved

2 PCS



12V - H3 - 55W

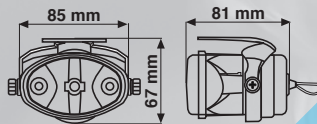

LED

BILUCE
POSIZIONE A LED+H3
2 LIGHTS
LED POSITION+H3

72351

FELIX 12V

Fari alogeni antinebbia, con luce di posizione a Led. Parabola con tecnologia multisuperficie

FELIX 12V

Halogen fog lights with Led position light. Advanced technology multi-surface reflector

Scatola / Box 12

E11 ECE approved

2 PCS



12V - H3 - 55W

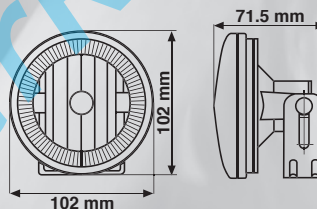

LED

BILUCE
POSIZIONE A LED+H3
2 LIGHTS
LED POSITION+H3

72353

ANGEL EYES 12V

Fari alogeni di profondità, con luce di posizione Multiled sulla cornice, Parabola con tecnologia multisuperficie

ANGEL EYES 12V

Halogen driving lights with position Led light. Advanced technology multi-surface reflector

Scatola / Box 12

E11 ECE approved

2 PCS



12V - H3 - 55W

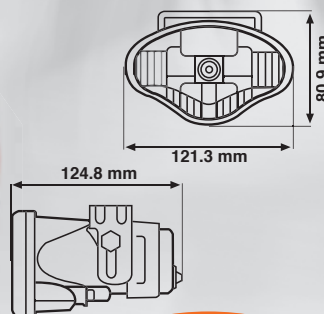

LED

BILUCE
POSIZIONE A LED+H3
2 LIGHTS
LED POSITION+H3

72354

CAT-EYES 12V

Fari alogeni di profondità, con luce di posizione Multiled, parabola con tecnologia multisuperficie

CAT-EYES 12V

Halogen driving lights with position Led light. Advanced technology multi-surface reflector

Scatola / Box 12

E11 ECE approved



Nuova centralina più sottile e leggera. Tempo di accensione ridotto a circa 2 secondi

New super thin ballast, 2 seconds only warm-up time.



H7



**H4
BI-XENON**

90230 H7 - 6500K

90232 H4 - 6500K BI-XENON

KIT-CONVERSIONE LAMPADA ALLO XENON 12V

Trasforma il normale faro alogeno in un potentissimo faro allo xenon. Illumina la notte a giorno. Nessuna modifica necessaria, non danneggia il proiettore originale. Kit di montaggio completo di trasformatore, centraline, lampada, cablaggi e accessori.

HID XENON CONVERSION KIT 12V

High intensity discharge system lamp. Xenon technology for 3 times brighter light output. More light with less power. Replace original halogen bulb without any modification. Up to 10 times longer lifespan than standard halogen bulb. D.I.Y. fitting. Kit includes: ballast, igniters, cables, bulb, fitting accessories and manual.

Scatola / Box 5

**RICAMBI LAMPADE
SPARE BULBS**

58205L H7 - 6.500K

58218L H4 - 6.500K Bi-Xenon

**RICAMBI STARTER+REATTORE
SPARE IGNITER AND BALLAST**

58203 UNIVERSAL 12V



Esempio comparativo delle diverse temperature colore in gradi kelvin

Example of different colour temperature in kelvin scale

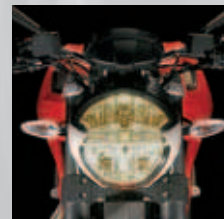

3.200K Halogen



6.500K Xenon

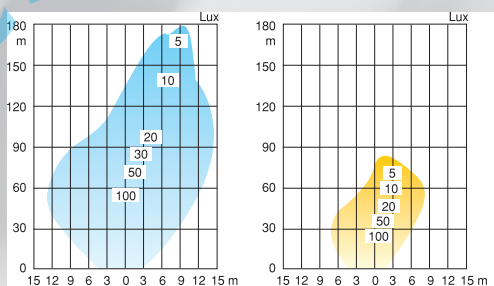

XENON

HALOGEN



58204

CHEAT-BOX

Centralina supplementare per il montaggio dei kit Xenon. Evita la segnalazione di "lampada bruciata" e previene l'interruzione dell'alimentazione da parte della centralina.

CHEAT-BOX

Additional device for the installation of Xenon kits. Avoids the signalling of "bulb-failure" and prevents the "cut-off" of the power by the control unit.

BLU-XE

**HID
WHITE**

Fascio luce **ULTRA-BIANCO**, Simile alle lampade XENON. Alta luminosità, 20% più brillantezza delle tradizionali lampade alogene

E' sufficiente sostituire le tradizionali lampade di serie con BLU-XE ed ottenere un fascio luce **ULTRA-BIANCO** simile ai proiettori a Scarica di Gas (HID).



NORMALE



BLU-XE

H1

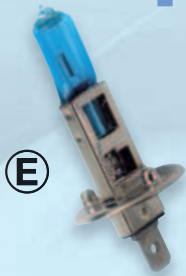

(E)

4150°K

91510

H1 - 12V - 55W
Lampada alogena Blu-Xe.
Attacco P14,5s.
Conf. 1 pz.

H1 - 12V - 55W
Blu-Xe halogen bulb.
P14,5s base.
Packaging 1 pc.

Scatola / Box 5 / 50

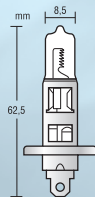

P14,5s



H4



(E)

4500°K

91511

H4 - 12V - 60-55W
Lampada alogena Blu-Xe.
Attacco P43t.
Conf. 1 pz.

H4 - 12V - 60-55W
Blu-Xe halogen bulb.
P43t base.
Packaging 1 pc.

Scatola / Box 5 / 50

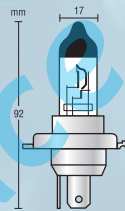

P43t



H7



(E)

4500°K

91512

H7 - 12V - 55W
Lampada alogena Blu-Xe.
Attacco PX26d.
Conf. 1 pz.

H7 - 12V - 55W
Blu-Xe halogen bulb.
PX26d base.
Packaging 1 pc.

Scatola / Box 5 / 50

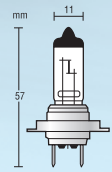

PX26d



S2



4150°K

91513

S2 - 12V - 35/35W
Lampada alogena Blu-Xe
Attacco BA20d.
Conf. 1 pz.

S2 - 12V - 35/35W
Blu-Xe halogen bulb.
BA20d base.
Packaging 1 pc.

D/Blister 10 / 100

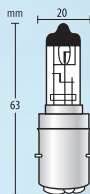

BA20d



S3



4150°K

91514

S3 - 12V - 15W
Lampada alogena Blu-Xe.
Attacco P26s.
Conf. 1 pz.

S3 - 12V - 15W
Blu-Xe halogen bulb.
P26s base.
Packaging 1 pc.

D/Blister 10 / 100

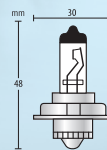

P26s



HS1



4150°K

91515

HS1 - 12V - 35/35W
Lampada alogena Blu-Xe
Attacco PX43t.
Conf. 1 pz.

HS1 - 12V - 35/35W
Blu-Xe halogen bulb.
PX43t base.
Packaging 1 pc.

D/Blister 10 / 100

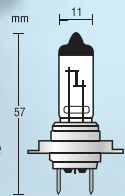

PX43t

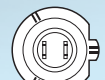



H1



91501

H1 - 12V - 55W
Lampada alogena.
Attacco P14,5s.
Confezione 1 pz.

H1 - 12V - 55W
Halogen bulb. P14,5s base.
Packaging 1 pc

D/Blister 10 / 100

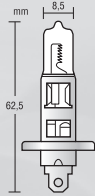

P14,5s



H4

91502

H4 - 12V - 60-55W
Lampada alogena.
Attacco P43t.
Confezione 1 pz.

H4 - 12V - 60-55W
Halogen bulb. P43t base.
Packaging 1 pc

D/Blister 10 / 100

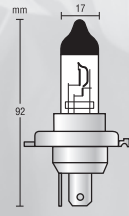

P43t



H7

91503

H7 - 12V - 55W
Lampada alogena.
Attacco PX26d.
Confezione 1 pz.

H7 - 12V - 55W
Halogen bulb. PX26d base.
Packaging 1 pc

D/Blister 10 / 100

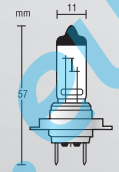

PX26d

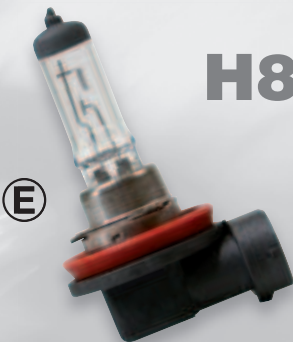

H8

91506

H8 - 12V - 35W
Lampada alogena.
Attacco PGJ19-1.
Confezione 1 pz.

H8 - 12V - 35W
Halogen bulb. PGJ19-1 base.
Packaging 1 pc

D/Blister 10 / 100

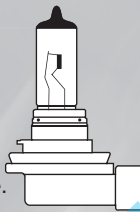

PGJ19-1



H11

91508

H11 - 12V - 55W
Lampada alogena.
Attacco PGJ19-2.
Confezione 1 pz.

H11 - 12V - 55W
Halogen bulb. PGJ19-2 base.
Packaging 1 pc

D/Blister 10 / 100

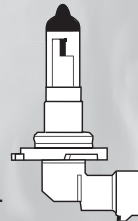

PGJ19-2



HB3

91507

HB3 - 12V - 65W
Lampada alogena.
Attacco P20d.
Confezione 1 pz.

HB3 - 12V - 65W
Halogen bulb. P20d base.
Packaging 1 pc

D/Blister 10 / 100

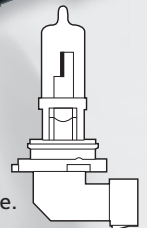

P20d



S3

91504

S3 - 12V - 15W
Lampada alogena.
Attacco P26s. Confezione 1 pz

S3 - 12V - 15W
Halogen bulb. P26s base.
Packaging 1 pc

D/Blister 10 / 100



HS1

91505

HS1 - 12V - 35/35W
Lampada alogena.
Attacco PX43t.
Confezione 1 pz

HS1 - 12V - 35/35W
Halogen bulb. PX43t base.
Packaging 1 pc

D/Blister 10 / 100



S3

91518	15W	1 pz
91519	30W	1 pz

LAMPADA A INCANDESCENZA

Attacco P26s. 12V.

BULB

Fitting P26s. 12V.

D/Blister 10 / 100



S2

91500

S2 - 12V - 35/35W
Lampada alogena.
Attacco BA20d. Confezione 1 pz.

S2 - 12V - 35/35W
Halogen bulb. Fitting BA20d.
Packaging 1 pc.

D/Blister 10 / 100

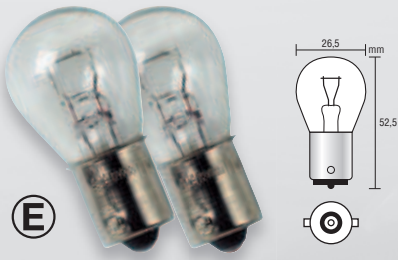

(E)

91520

BA15s

P21W - 12V - 21W

Lampada 1 filamento.
Attacco BA15s. Confezione 2 pz

P21W - 12V - 21W

Single filament bulb. BA15s base.
Packaging 2 pcs

D/Blister 10 / 200



(E)

91521

BAY15d

P21/5W - 12V - 21/5W

Lampada 2 filamenti. Attacco BAY15d.
Confezione 2 pz

P21/5W - 12V - 21/5W

Double filament bulb. BAY15d base.
Packaging 2 pcs

D/Blister 10 / 200

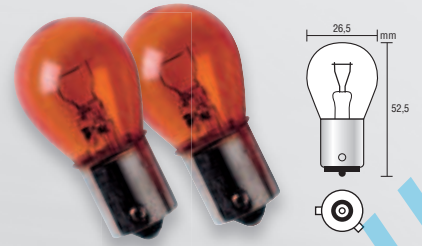

91522

BAU15s

PY21W - 12V - 21W

Lampada arancio 1 filamento.
Attacco BAU15s. Confezione 2 pz

PY21W - 12V - 21W

Amber single filament bulb.
BAU15s base. Packaging 2 pcs

D/Blister 10 / 200

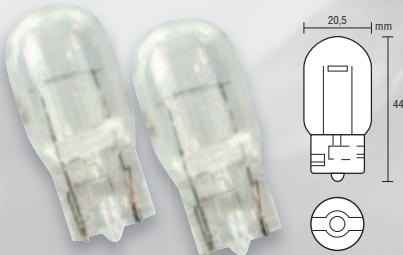

91536

W3x16d

W21W - 12V - 21W

Lampada 1 filamento con zoccolo
in vetro. Attacco W3x16d.
Confezione 2 pz.

W21W - 12V - 21W

1 filament Wedge base bulb.
W3x16d base. Packaging 2 pcs.

D/Blister 10 / 200



91537

W3x16q

W21/5W - 12V - 21W

Lampada 2 filamenti con zoccolo
in vetro. Attacco W3x16d.
Confezione 2 pz.

W21/5W - 12V - 21W

2 filaments wedge base bulb.
W3x16d base. Packaging 2 pcs.

D/Blister 10 / 200

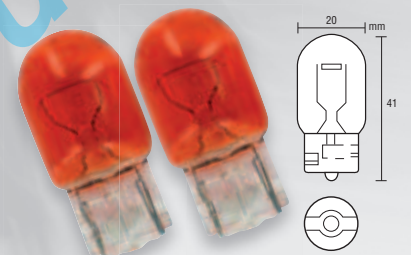

91538

W3x16d

WY21W - 12V - 21W

Lampada 1 filamento con zoccolo
in vetro. Attacco W3x16d.
Confezione 2 pz.

WY21W - 12V - 21W

1 filament wedge base bulb.
W3x16d base. Packaging 2 pcs.

D/Blister 10 / 200

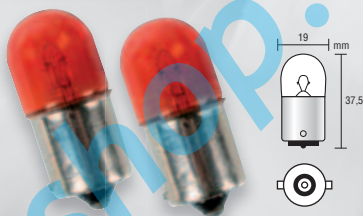

91523

BA15s

R10W - 12V - 10W

Lampada sferica. Attacco BAU15s.
Confezione 2 pz.

R10W - 12V - 10W

Single filament bulb. BAU15s base.
Packaging 2 pcs.

D/Blister 10 / 200



91528

BA9s

T4W - 12V - 4W

Lampada sferica. Attacco BA9s.
Confezione 2 pz.

T4W - 12V - 4W

Single filament bulb. BA9s base.
Packaging 2 pcs.

D/Blister 10 / 200



91540

W2.1x9.5d

W3W - 12V - 3W

Lampada con zoccolo in vetro.
Attacco W2.1x9.5d. Confezione 2 pz

W3W - 12V - 3W

Wedge base bulb. W2.1x9.5d base.
Packaging 2 pcs.

D/Blister 10 / 200

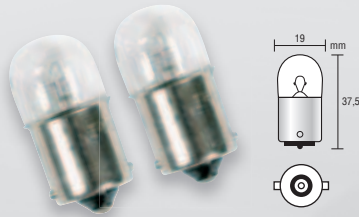

91525

BA15s

R5W - 12V - 5W

Lampada sferica. Attacco BA15s.
Confezione 2 pz

R5W - 12V - 5W

Single filament bulb. BA15s base.
Packaging 2 pcs

D/Blister 10 / 200



91526

BA15s

R10W - 12V - 10W

Lampada sferica. Attacco BA15s.
Confezione 2 pz

R10W - 12V - 10W

Single filament bulb. BA15s base.
Packaging 2 pcs

D/Blister 10 / 200



91530

BAY9s

H21W - 12V - 21W

Lampada alogena micro.
Attacco BAY9s. Confezione 2 pz

H21W - 12V - 21W

Halogen bulb. BAY9s base.
Packaging 2 pcs

D/Blister 10 / 200

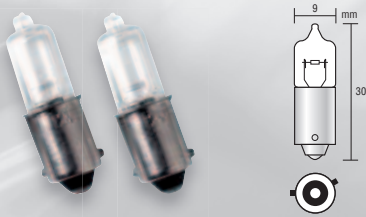

91531

BAX9s

H6W - 12V - 6W

Lampada alogena micro.
Attacco BAX9s. Confezione 2 pz

H6W - 12V - 6W

Halogen bulb. BAX9s base.
Packaging 2 pcs

D/Blister 10 / 200



91535

SV8,5-8

C5W - 12V - 5W

Lampada siluro tubolare.
Attacco SV8,5-8. Confezione 2 pz

C5W - 12V - 5W

Festoon bulb. SV8,5-8 base.
Packaging 2 pcs

D/Blister 10 / 200



91541

W2x4.6d

W1,2W - 12V - 1,2W

Lampada con zoccolo in vetro.
Attacco W2x4.6d. Confezione 2 pz

W1,2W - 12V - 1,2W

Wedge base bulb. W2x4.6d base.
Packaging 2 pcs

D/Blister 10 / 200



58111

SV8,5-8

C10W - 12V - 10W

Lampada siluro tubolare.
Attacco SV8,5-8. Confezione 2 pz

C10W - 12V - 10W

Festoon bulb. SV8,5-8 base.
Packaging 2 pcs.

D/Blister 10 / 200

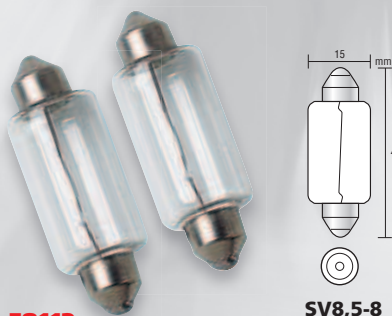

58112

SV8,5-8

15x41 MM - 12V - 18W

Lampada siluro tubolare.
Attacco SV8,5-8. Confezione 2 pz

15x41 MM - 12V - 18W

Festoon bulb. SV8,5-8 base.
Packaging 2 pcs.

D/Blister 10 / 100



58116

SV8,5-8

11x44 MM - 12V - 10W

Lampada siluro tubolare.
Attacco SV8,5-8. Confezione 2 pz

11x44 MM - 12V - 10W

Festoon bulb. SV8,5-8 base.
Packaging 2 pcs.

D/Blister 10 / 100

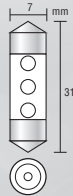

SV8,5-8

- **58380** Rosso - Red
- **58381** Arancio - Amber
- **58382** Blu - Blue
- **58384** Bianco - White

LAMPADE SILURO A LED SV8,5-8 - 10x31 mm (2 pz)
Illuminazione targa.

MULTI-LED FESTOON LAMPS SV8,5-8 - 10x31 mm (pair-pack)
Licence plate lights.

D/Blister 10 / 100



SV8,5-8

- **58390** Rosso - Red
- **58392** Blu - Blue
- **58393** Verde - Green
- **58394** Bianco - White
- **58397** 7 colori - 7 colours

LAMPADE SILURO A LED SV8,5-8 - 10x36 mm (2 pz)
Illuminazione targa.

MULTI-LED FESTOON LAMPS SV8,5-8 - 10x36 mm (pair-pack)
Licence plate lights.

D/Blister 10 / 100

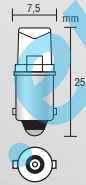

BA9s

- **58402** Blu - Blue
- **58403** Verde - Green
- **58404** Bianco - White
- **58405** Viola - Purple

MICRO LAMPADE A LED BA9s (2 pz)
Illuminazione cruscotto.

LED MICRO LAMPS BA9s (pair-pack)
Dashboard lights.

D/Blister 10 / 100



W2x4.6d

- **58485** Blu - Blue
- **58486** Verde - Green
- **58487** Rosso - Red
- **58488** Viola - Purple
- **58489** Bianco - White

LED T3 (5 pz.) KIT ILLUMINAZ. CRUSCOTTO
Alta luminescenza, lunga durata

LED T3 (5 pcs) CARSTYLING COCKPIT COLOUR KIT
Long lifespan, over 10.000 hours

D/Blister 10 / 200



W2x4.6d



- **58480** Blu - Blue
- **58481** Verde - Green
- **58482** Rosso - Red
- **58483** Viola - Purple
- **58484** Bianco - White

LED T5 (5 PZ.) KIT ILLUMINAZ. CRUSCOTTO
Alta luminescenza, lunga durata

LED T5 (5 PCS) CARSTYLING COCKPIT COLOUR KIT
Long lifespan, over 10.000 hours

D/Blister 10 / 200



W2x4.6d

- **58410** Rosso - Red
- **58412** Blu - Blue
- **58413** Verde - Green
- **58414** Bianco - White

MICRO LAMPADE A LED T5 ZOCCOLO IN PLASTICA (2 pz)
Illuminazione cruscotto e strumenti

T5 LED MICRO LAMPS (pair-pack) WEDGE BASE
Dashboard and instrument lights

D/Blister 10 / 100

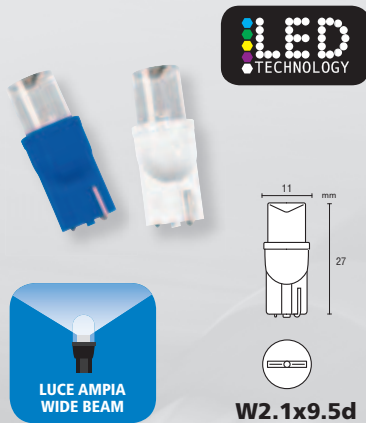

- **91545** Blu - Blue
- **91546** Bianco - White
- **58143** Arancio - Amber
- **58144** Verde - Green

COLOR-LED T10 (2 pz)

Leds ad alta luminescenza. Montaggio in sostituzione alle comuni lampade W5W con zoccolo in vetro (luci di posizione, illuminazione cruscotto, indicatori di direzione...).

COLOR-LED T10 (2 pcs)

Wedge base led bulbs

D/Blister 10 / 100



- **91549** Blu - Blue
- **91550** Bianco - White

COLOR-LED T10 (2 pz)

Attacco W2.1x9.5d (T10). 12V. Luce focalizzata. Alta luminescenza. Corrispondenti alle lampade tradizionali tipo W5W oppure W3W da usarsi per luci posizione, strumentazioni o indicatori di direzione.

COLOR-LED T10 (2 pcs)

Fitting W2.1x9.5d (T10). 1 Watt. 12V. Focus-beam. Ultra-bright. Replace W5W or W3W type lamp as dashboard lights, corner and rear lights.

D/Blister 10 / 100



- **91553** Blu - Blue
- **91554** Bianco - White

HYPER-LED, LED AD ALTA LUMINESCENZA

Attacco W2.1x9.5d (T10). 12V. Potenza maggiorata 1 Watt. Luce ampia. Alta luminescenza. Corrispondenti alle lampade tradizionali tipo W5W oppure W3W da usarsi per luci posizione, strumentazioni o indicatori di direzione.

HYPER-LED, WEDGE BASE LED BULBS

Fitting W2.1x9.5d (T10). 1 Watt. 12V. Wide-beam. Ultra-bright. Replace W5W or W3W type lamp as dashboard lights, corner and rear lights.

D/Blister 10 / 100



- **58490** Blu - Blue
- **58491** Verde - Green
- **58492** Rosso - Red
- **58493** Viola - Purple
- **58494** Bianco - White

B8,5D - COPPIA LAMPADINE A LED PER ILLUMINAZIONE CRUSCOTTO

Alta luminescenza, lunga durata

B8,5D - CARSTYLING COCKPIT COLOUR LED 2 pcs

Long lifespan, over 10.000 hours

D/Blister 10 / 200



POWER 54
18 SMD x 3 chips

6500°K



58512
H7 - 12V
LAMPADA SPECIALE A LED SMD MULTI-CHIP
Attacco PX26d. Confezione 1 pz.
H7 - 12V
MULTI-CHIP SMD LED LAMP
PX26d base. Packaging 1 pc.

D/Blister 10 / 100

POWER 54
18 SMD x 3 chips

6500°K



58513
H4 - 12V
LAMPADA SPECIALE A LED SMD MULTI-CHIP
Attacco P43t. Confezione 1 pz.
H4 - 12V
MULTI-CHIP SMD LED LAMP
P43t base. Packaging 1 pc.

D/Blister 10 / 100

POWER 15
5 SMD x 3 chips

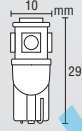

T10
W2.1x9.5d

58454
T10 - 12V
LAMPADE SPECIALI A LED SMD MULTI-CHIP
Attacco W2.1x9.5d. Confezione 2 pz.
T10 - 12V
MULTI-CHIP SMD LED LAMPS
W2.1x9.5d base. Packaging 2 pcs.

D/Blister 10 / 100

Queste lampadine a led hanno un'elevata intensità luminosa e rendono il veicolo visibile a grande distanza anche in condizioni atmosferiche critiche (nebbia, pioggia, ...). Il fascio luminoso proiettato però, non è adeguato ad illuminare la carreggiata durante la guida notturna.

These high-brightness led bulbs make your vehicle visible at high distances and in all atmospheric conditions (fog, rain, ...). The projected light beam is not suitable for driving on the road during the night.

POWER 2
1 SMD x 2 chips

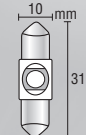
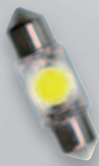

C5-10W
58447
10x31 MM - 12V
LAMPADA SPECIALE A LED SMD MULTI-CHIP
Attacco SV8,5-8. Confezione 1 pz.
10x31 MM - 12V
MULTI-CHIP SMD LED LAMP
SV8,5-8 base. Packaging 1 pc.

D/Blister 10 / 100

POWER 2
1 SMD x 2 chips

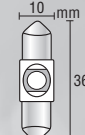

C5-10W
58448
10x36 MM - 12V
LAMPADA SPECIALE A LED SMD MULTI-CHIP
Attacco SV8,5-8. Confezione 1 pz.
10x36 MM - 12V
MULTI-CHIP SMD LED LAMP
SV8,5-8 base. Packaging 1 pc.

D/Blister 10 / 100

POWER 4
2 SMD x 2 chips

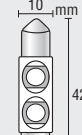

C5-10W
58449
10x42 MM - 12V
LAMPADA SPECIALE A LED SMD MULTI-CHIP
Attacco SV8,5-8. Confezione 1 pz.
10x42 MM - 12V
MULTI-CHIP SMD LED LAMP
SV8,5-8 base. Packaging 1 pc.

D/Blister 10 / 100

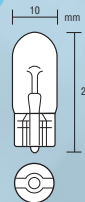

W2.1x9.5d

BLU-XE

VETRO TINTO IN PASTA
BLUE-DYED GLASS

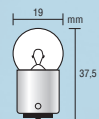
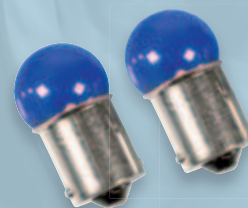

BA15s

58359
LAMPADA BLU-XE CON ZOCCOLO IN VETRO
12V - W5W
Per luci di posizione, illuminazione targa, plafoniera, baule.
Attacco W2.1x9.5d.
12V BLU-XE WEDGE BASE LAMP W5W
For parking, plate light; trunk/map reading light.
Base W2.1x9.5d.

D/Blister 10 / 100

58369
LAMPADA BLU-XE SFERICA 12V - R5W
Per luci di posizione.
Attacco BA15s.
12V BLU-XE SINGLE FILAMENT LAMP R5W
For parking lights.
Base BA15s.

D/Blister 10 / 100